



medi

Product catalogue
circaid® range

medi. I feel better.





Driving the future in compression therapy

**A strong brand. A wide-ranging product range.
Convincing concepts.**

medi World of Compression: signpost to the future with more than 70 years' competence in the field of compression. Your partner for the highest demands on quality, innovation and design. Let's shape the future together and create positive brand experiences – for you and your clients!

A different approach in compression therapy

circaid adjustable compression devices allow for holistic therapy concepts and offer the perfect portfolio addition to established medical compression stockings.

Position yourself as the specialist in compression therapy. Offer modern solutions for the decongestive therapy in venous and lymphatic treatment as well as an opportunity for patients who have challenges with medical compression stockings.

We have the direct connection

**To communicate. To co-operate. To be there for each other.
The medi service team respects and values this
requirement seriously.**

Therefore, our office not only offers consultants, but also a state-of-the art communications system and logistics.

Just-in-time: in consultancy, in service, in ordering and delivery. We are always here for you. This is your medi export service team.

Hotline for consultancy, ordering, problem solutions

T +49 921 912 -0
F +49 921 912 -781

You can visit our website:	www.medi.de/en
or contact us by e-mail:	export@medi.de
or order by e-mail:	orders@medi.de



6

General



26

**circaid juxtalite /
circaid juxtalite hd**

Adjustable compression device for
venous diseases.



76

medi skin care

Skin care products for soothing
compression therapy.



10

**circaid adjustable
compression devices**



80

Service



18

circaid juxtacures

Adjustable compression device for
the decongestion of venous oedema.

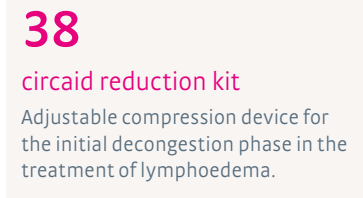

38

circaid reduction kit

Adjustable compression device for
the initial decongestion phase in the
treatment of lymphoedema.



50

circaid juxtafit

Adjustable compression device for
lymphatic diseases.



More than just a manufacturer

medi produces medical aids for a variety of conditions and life situations. But we don't see ourselves solely as a manufacturer. On the contrary, we handle our own research and development, technology, production, marketing and sales in-house – always keeping our focus on the market, its demands and variables, and the medi vision.

medi offers products in five business divisions: Phlebology, Hospital, Orthopaedics, Footcare and Wound Care. These products are used and distributed by medical supply stores, hospitals and clinics, doctors' practices and therapists.

In other words, specialists who know which users need which aids to improve their state of health and quality of life.

What we're proud of and what makes our products so special is that they're free of negative side effects.

Our range of products primarily includes medical compression stockings and adjustable compression devices for people with vein disorders, lipoedema and lymphoedema, supports and braces for the conservative and post-operative treatment of orthopaedic injuries and disorders, stockings for the prevention of thrombosis, anti-embolism stockings for use after vein surgery, compression garments for use after plastic and cosmetic surgery plus a variety of therapy-supporting products.

We support our partners in the sale and supply of our products and have developed intelligent concepts and services for this purpose.

Quality Certificates

As a manufacturer of medical products, medi has a high regard and awareness for quality. Product and system certificates prove that all legal requirements are met.



CE mark

Our medi medical devices meet all of the requirements of the European Regulation 2017/745 (MDR) and of the German Medical Devices Act. In accordance with regulations, our products are subject to the conformity assessment procedures and are granted the CE mark. As a kind of “passport for industrial products”, the CE mark guarantees free trade within the European Economic Area (EEA).



EN ISO 13485

medi maintains the quality management system according to the EN ISO 13485. Since 1996 we have demonstrated our quality status to our customers with a certificate. Since then, medi has enhanced the opportunities offered by this standard to permanently improve products from the business units Phlebology, Orthotics, Footcare, Woundcare and Hospital in order to organise safer and more efficient processes and procedures. We define customer satisfaction as a decisive measure of quality.

circaid® – Indication overview

Due to product features we recommend to use circaid products as follows.*

Venous diseases

Initial decongestion of phleboedema in the lower leg

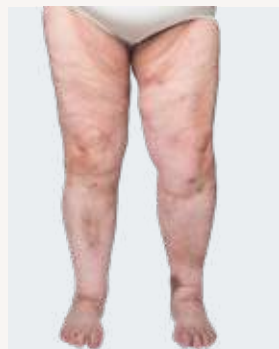

circaid® juxtacures®

Alternative to traditional compression bandaging for the decongestion of phleboedema especially in leg ulcers.

- Adjustable to the patients initial leg circumferences and shape
- Can be reduced to decreasing limb volume
- Adjustable, measurable and readjustable compression
- Suitable for wet leg ulcers with high exudate



Alternative for patients who have challenges with round-knitted medical compression stockings



circaid® juxtalite®

Easy to apply adjustable compression device for the treatment of venous diseases.

- Simple donning and doffing
- Adjustable, measurable and readjustable compression
- Pleasant wearing comfort
- Suitable for dry leg ulcers



More robust adjustable compression device

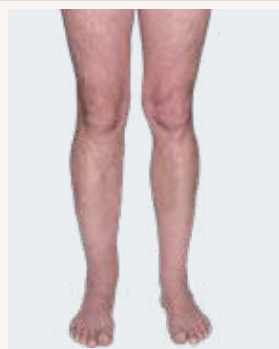

circaid® juxtalite® hd

Adjustable compression device for the treatment of venous disease and accompanying oedema.

- More robust material for complex oedema
- Suitable for moderate to severe tendency for oedema or accompanying lymphoedema
- Simple donning and doffing
- Pleasant wearing comfort



* Please consider, that this recommendation does not replace the diagnosis and consultation of a medical healthcare professional.

Lymphatic diseases

Initial decongestion of lymphoedema in the leg and arm



circaid® reduction kit

Alternative to traditional compression bandaging in initial decongestion phase.

- Adjustable to the patients initial limb circumferences and shape
- Can be reduced to decreasing limb volume
- Adjustable, measurable and readjustable tension



Optimising reduction results of the decongestion phase



circaid® juxtafit®

Easy to apply adjustable compression device for the treatment of lymphoedema.

- Simple donning and doffing
- Adjustable, measurable compression
- Allows for smaller reduction – suitable for rebound oedema



Alternative for patients who have challenges with flat-knitted medical compression stockings

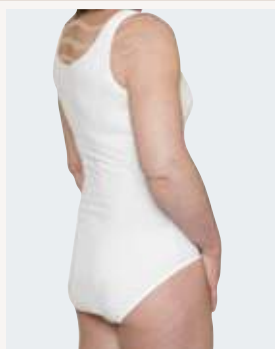

circaid® juxtafit®

Easy to apply adjustable compression device for the long term maintenance phase of lymphoedema.

- Simple donning and doffing
- Adjustable, measurable compression
- Pleasant wearing comfort even during the night







circaid[®] adjustable compression devices

**Adjustable compression garments for the
treatment of venous and lymphatic diseases.**

circaid garments are an alternative to traditional compression bandaging in the treatment of phleboedema and lymphoedema. Also circaid garments are a compressive solution for those patients who have challenges with the established medical compression stockings. Its easy donning and doffing process promotes self-management and thus an increased patient concordance as well as an improved quality of life. The ability to instantly readjust the circaid system helps to consistently apply compression to a reducing limb and avoids sliding down of the garment for better treatment outcomes and satisfied patients.

circaid[®] features

Overview of circaid characteristics.



Built-In-Pressure

Built-In-Pressure[®] System

To set, control and re-adjust the correct therapeutic compression range



Juxtaposed band

Juxtaposed band system

- Optimum fit thanks to interlocking bands
- Each strap can be readjusted while on the limb



Breathe-O-Prene

Breathe-O-Prene

- Breathable and latex-free material
- Odour-inhibiting with antibacterial effect



Variety

Variety

- Wide range of care options
- Many sizes available



Easy handling

Easy handling

- Simple donning and doffing
- Eases handling for the patient



Inelastic

Inelastic

- Inelastic material for an effective therapy and pleasant wearing comfort
- Inspired by nature

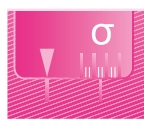

Built-In-Tension

Built-In-Tension System

- To set and control the correct therapeutic level of tension
- For circaid reduction kit products only



All circaid products are latex-free.





circaid® Built-In-Pressure® System (BPS)

circaid adjustable compression devices are engineered with the ability to be set to precise compression ranges with a graduated compression profile from the ankle up the leg.

The user-friendly design of the circaid Built-In-Pressure System (BPS) enables patients to achieve the necessary compression ranges needed for the treatment and management of chronic venous and lymphatic disease.

With the circaid Built-In-Pressure System (BPS) guide card patients are able to set their prescribed compression range while donning their garment and to readjust the compression range during the day as needed. Therefore, the appropriate compression range is ensured throughout the period of wear. Simultaneously, it is very simple to verify the correct range of applied pressure.





Inspired by nature.

circaid products have an animal role model: the giraffe with its specific skin structure. Giraffes have venous pressures of more than 250 mmHg at their front and hind legs – three times more than humans. But they do not suffer from lymphoedema or venous diseases, even though they are on their feet the whole day and sometimes also sleep while standing. But why? In contrast to humans giraffes have inelastic skin, meaning it does not stretch.*

The founder of circaid was inspired from this “natural compression” and designed the first patented inelastic circaid leg garment. This first garment has been further developed to today´s circaid products (short for circulation aid).

* Sathar F, Ludo Badlangana N, Manger PR. Variations in the thickness and composition of the skin of the giraffe. *Anatomical record* 2010;293(9):1615-1627.

medi Therapy Concept Leg Ulcer

Effective therapy chain for guideline-compliant and patient-individual treatment.

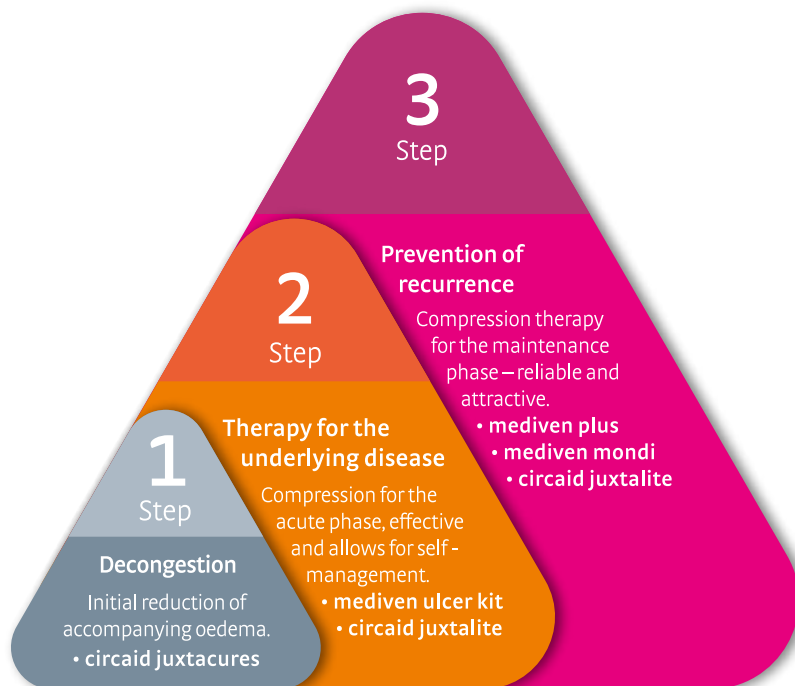

Initial decongestion of accompanying phleboedema or phlebo-lymphoedema.

• **circaid® juxtacures®**

2

Therapy for the underlying disease



Compression for treatment of chronic venous insufficiency.

- mediven® ulcer kit
- circaid® juxtalite®

3

Prevention of recurrence



Compression to maintain treatment success.

- mediven® round knit
- mediven® flat knit
- circaid® juxtalite®

medi. I feel better.



1
Phase



circaid® juxtacures®

Adjustable compression device for decongestion of the lower leg – the alternative to traditional compression bandaging.

medi tip*:

Due to product features we recommend circaid juxtacures for:

- Women / men
- Initial decongestion of phleboedema and phlebo-lymphoedema
- Up to 24 hour compression therapy
- Mobile / immobile patients

Indications

- Chronic venous insufficiency
- Varicose veins
- Post Thrombotic Syndrome
- Venous Stasis Ulcer / Mixed Leg Ulcer
- Post Sclerotherapy
- Dependent oedema

Product features

- Easy handling – simple donning and doffing
- Customisable to the patient's individual circumferences and shape
- Adjustable to reducing leg circumferences during decongestion
- circaid Built-In-Pressure System (BPS): adjustable, measurable and re-adjustable compression – 85 % of users reached the targeted compression value after first instruction¹
- Latex-free, odour-inhibiting material with anti-bacterial effect
- Re-adjusting the individual bands avoids pressure loss and thus sliding down of the garment – supporting oedema reduction effectively²
- **New:** Also available with new compressive undersock
 - Applies graduated compression to the foot and ankle
 - Graduated compression continues into the leg portion of the undersock

Benefits

- Easy handling – time-saving and less susceptible to error¹
- Compression – essential part of guideline-compliant treatment of venous leg ulcer
- Cost savings due to faster healing rates²
- Increased patient-concordance: 94.6 % of the users experience the wearing comfort as pleasant¹
- Increased mobility: possibility of wearing regular footwear¹
- Promotes self-management thanks to easy handling
- Cost- and time-saving compared to compression bandages:³
 - Cost reduction of wound dressings: 55.5 %
 - Cost reduction of compression material: 72.3 %
 - Reduction of nursing time: 58.7 %

Adjustable compression

20 – 30 mmHg
30 – 40 mmHg
40 – 50 mmHg

Product benefits



Built-In-Pressure®



Variety



Juxtaped band



Easy handling



Inelastic



Breathe-O-Prene



Colours

Beige
S

S = Standard

Note

For more information and handling videos please visit:
[medi.biz/juxtacures](https://www.medi.biz/juxtacures)

* Please consider, that this recommendation does not replace the diagnosis and consultation of a medical healthcare professional.

Studies

¹ Protz K et al. Comparison of handling, pressure and wearing comfort of different compression devices for decongestion therapy. *Veins and Lymphatics* 2018;7:7989:137–138.

² Stather PW et al. Review of adjustable velcro wrap devices for venous ulceration. *In Wound J* 2019. DOI:10.1111/iwj.13116; Epub ahead of print.

³ Elvin S. Cost efficacy of using circaid juxtacures and UCS Debridement cloths. *Journal of Community Nursing* 2015;29(2):62–65.



circaid® juxtacures®

Your order includes

- 1 inelastic adjustable compression garment
- 1 circaid Built-In-Pressure System (BPS) guide card
- 1 pair of circaid compression anklets
- 1 pair of circaid undersleeves lower leg
- 6 small additional hook tabs
- 1 paper measuring tape



circaid juxtacures

Styles	AD	AD	AD
			
	Short	Standard	Long
Art. No.	JU42709000	JU42N09000	JU42009000





circaid juxtacures with BPS guide card

circaid® juxtacures® with circaid® compressive undersock

Your order includes

- 1 inelastic adjustable compression garment
- 1 circaid Built-In-Pressure System (BPS) guide card
- 1 pair of circaid compressive undersocks moderate
- 6 small additional hook tabs
- 1 paper measuring tape

Styles	AD	AD	AD
			
	Short	Standard	Long
Art. No.	JU4M709000	JU4MN09000	JU4M009000



circaid juxtacures with circaid compressive undersock

Measurement chart

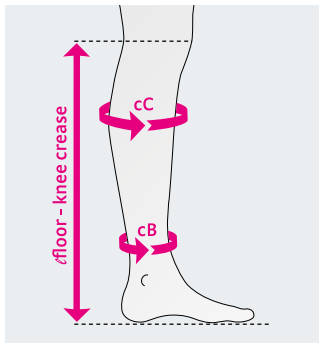

Circumferences in cm				
Adjustable garment to cut according to individual circumferences.				
Circumference measurements in cm		Minimum	Maximum	
cB		19	42	
cC		25	64	
Sizing measurement in cm		Short	Standard	Long
floor - knee crease		< 44	44 - 49	> 49



circaid® foot options

The following foot options are recommended to wear in combination with circaid juxtacures.

Note

It is recommended to always wear a circaid foot option in combination with a circaid leg garment. The indications of the circaid foot options are identical to the indications of the corresponding circaid leg garment. Please order separately.

circaid® power added compression band (pac band)

Additional compression for the arch of the foot and ankle.

Product details

- Additional compression to the foot with mild to severe tendency for oedema
- Targets the arch of the foot and around the malleoli
- Can be trimmed to fit almost every foot shape
- Easy handling
- Lightweight and breathable material
- Available in standard, large and extra large
- Bilateral use (left or right foot)



circaid power added compression band (pac band)

Measurement chart

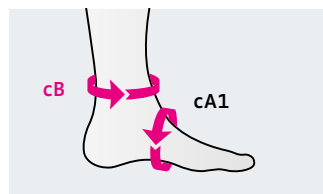

Circumferences in cm	Standard	Large	Extra Large
cB	19 – 27	25 – 50	45 – 56
cA1	19 – 36	22 – 41	22 – 41
Art. No.	JU5P001000	JU5P002000	JU5P003000

circaid® compression anklet

Standard compression option for foot and ankle.

Product details

- Provides compression to the foot and ankle
- Can be combined with other circaid foot options
- Available in standard and large



circaid compression anklet

Measurement chart

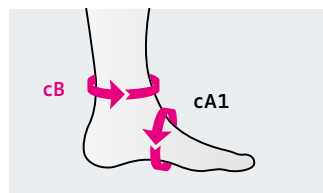

Circumferences in cm	Standard	Large
cB	19 – 27	25 – 50
cA1	19 – 36	22 – 41
Art. No.	JU51001000	JU51002000

circaid® compressive undersock

Easy-to-apply liner with targeted compression for foot and ankle.

Product details

- Applies graduated compression to the foot and ankle
- Graduated compression continues into the leg portion of the undersock
- Soft material for pleasant wearing comfort
- Available in 15 – 25 mmHg (moderate compression) and 25 – 35 mmHg (firm compression)
- Available in standard and large



circaid compressive undersock

Measurement chart

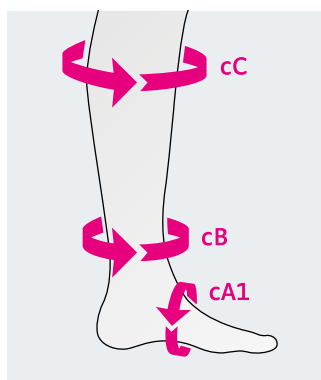

	Standard	Large
cC	26 – 54	41 – 64
cB	19 – 27	25 – 42
cA1	19 – 32	24 – 41

Size	Strength	Art. No.
Standard	Moderate	JU5M001000
Large	Moderate	JU5M002000
Standard	Firm	JU5F001000
Large	Firm	JU5F001000

circaid® toe cap

Additional compression for the toes.

Product details

- Provides light to moderate compression
- Individually adjustable length of the toes
- Designed for left or right limb use
- It is recommended to always wear the circaid toe cap with a circaid foot option



circaid toe cap

Measurement chart

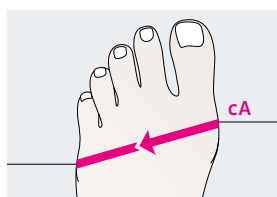

Circumference in cm	2	3	4	5	6
cA	20 – 22	22 – 24	24 – 26	26 – 28	28 – 30
Art. No.	JU5T002000	JU5T003000	JU5T004000	JU5T005000	JU5T006000

circaid® accessories

circaid® liner

Additional wearing comfort.

- Can be worn directly against the skin underneath circaid products
- Extra comfort
- Note: does not provide therapeutic compression

Article	Art. No.	Size
Undersleeve	JULS709000	One size



circaid liner



2
Phase

3
Phase



circaid® juxtalite®

Adjustable compression device for treating venous diseases after initial oedema decongestion.

medi tip*:

Due to product features we recommend circaid juxtalite for:

- Women / men
- Patients who have challenges with medical compression stockings
- Up to 24 hour compression therapy
- Mobile / immobile patients

Indications

- Chronic venous insufficiency
- Varicose veins
- Post Thrombotic Syndrome
- Venous Stasis Ulcer / Mixed Leg Ulcer
- Post Sclerotherapy
- Dependent oedema

Product features

- Easy handling – simple donning and doffing
- circaid Built-In-Pressure System (BPS): adjustable, measurable and re-adjustable compression
- Breathe-O-Prene: breathable material with high working pressure
- Latex-free, odour-inhibiting material with anti-bacterial effect
- Re-adjusting the individual bands avoids pressure loss and thus sliding down of the garment^{1,2}
- **New:** Also available with new compressive undersock
 - Applies graduated compression to the foot and ankle
 - Graduated compression continues into the leg portion of the undersock

Benefits

- Offering an alternative therapy concept for patients who are not able to apply or tolerate medical compression stockings
- Faster healing rates of venous leg ulcer^{1,2}
- Promotes self-management thanks to easy handling¹

Adjustable compression

20 – 30 mmHg
30 – 40 mmHg
40 – 50 mmHg

Product benefits

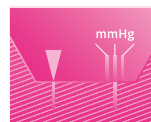

Built-In-Pressure®



Variety



Juxtaposed band



Easy handling



Inelastic



Breathe-O-Prene



Colours



S = Standard

Note

For more information and handling videos please visit:
medi.biz/jl

* Please consider, that this recommendation does not replace the diagnosis and consultation of a medical healthcare professional.

Studies

¹ Mosti G et al. Adjustable compression wrap devices are cheaper and more effective than inelastic Bandages for venous leg ulcer healing. A Multicentric Italian Randomized Clinical Experience. *Phlebology* 2020;35(2):124–133.

² Stather PW et al. Review of adjustable velcro wrap devices for venous ulceration. In *Wound J* 2019;16(4):903–908.

circaid® juxtalite®

Your order includes

- 1 inelastic adjustable compression garment
- 1 circaid Built-In-Pressure System (BPS) guide card
- 1 circaid undersleeve lower leg
- 1 pair of circaid compression anklets



circaid juxtalite

		Short	Long
Size / Art. No.	S	JU15702000	JU15002000
	M	JU15703000	JU15003000
	M-L	JU15713000	JU15013000
	L	JU15704000	JU15004000
	L-X	JU15714000	JU15014000
	XL	JU15705000	JU15005000
	XL-X	JU15715000	JU15015000
	XXL	JU15706000	JU15006000

Measurement chart

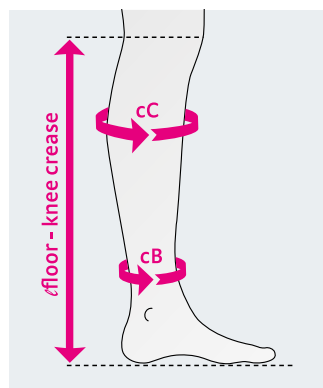

Circumferences in cm	S	M	M-X	L
cC	26-36	33-44	44-54	41-51
cB	19-22	22-27	22-27	25-32
	L-X	XL	XL-X	XXL
cC	51-61	37-48	48-61	53-64
cB	25-32	30-37	30-37	35-42
Sizing measurement in cm	Short	Long		
ℓ floor - knee crease	< 44	> 44		

circaid® juxtalite® with circaid® compressive undersock

Your order includes

- 1 inelastic adjustable compression garment
- 1 circaid Built-In-Pressure System (BPS) guide card
- 1 pair of circaid compressive undersocks moderate



circaid juxtalite with circaid compressive undersock

		Short	Long
Size / Art. No.	S	JU1M702000	JU1M002000
	M	JU1M703000	JU1M003000
	M - X	JU1M713000	JU1M013000
	L	JU1M704000	JU1M004000
	L - X	JU1M714000	JU1M014000
	XL	JU1M705000	JU1M005000
	XL - X	JU1M715000	JU1M015000
	XXL	JU1M706000	JU1M006000

Measurement chart

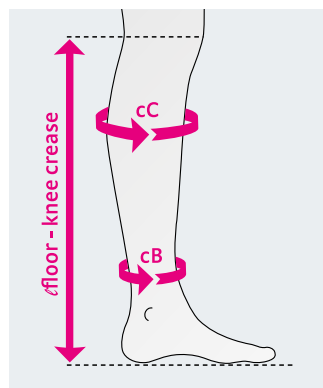

Circumferences in cm	S	M	M - X	L
cC	26 - 36	33 - 44	44 - 54	41 - 51
cB	19 - 22	22 - 27	22 - 27	25 - 32
	L - X	XL	XL - X	XXL
cC	51 - 61	37 - 48	48 - 61	53 - 64
cB	25 - 32	30 - 37	30 - 37	35 - 42
Sizing measurement in cm	Short	Long		
floor - knee crease	< 44	> 44		

2
Phase

3
Phase



circaid® juxtalite® hd

More robust adjustable compression device – thicker material ideal for the treatment after initial decongestion of moderate to severe oedema.

medi tip*:

Due to product features we recommend circaid juxtalite hd for:

- Women / men
- Moderate to severe tendency for phleboedema
- Patients who have challenges with medical compression stockings
- Up to 24 hour compression therapy

Indications

- Chronic venous insufficiency
- Varicose veins
- Post Thrombotic Syndrome
- Venous Stasis Ulcer / Mixed Leg Ulcer
- Post Sclerotherapy
- Dependent oedema

Product features

- Thicker and more robust material – for moderate to severe phleboedema
- Updated band design for improved fit, avoiding wrinkles and preventing eventual window oedema
- Easy handling – simple donning and doffing
- circaid Built-In-Pressure System (BPS): adjustable, measurable and re-adjustable compression
- Re-adjusting the individual bands avoids pressure loss and thus sliding down of the garment^{1,2}
- Breathe-O-Prene: breathable material with high working pressure
- Latex-free, odour-inhibiting material with anti-bacterial effect
- Comes with compressive undersock moderate
 - Applies graduated compression to the foot and ankle
 - Graduated compression continues into the leg portion of the undersock

Benefits

- Easy handling – time-saving and less susceptible to error³
- Cost savings due to faster healing rates¹
- Increased patient-concordance: 94.6 % of the users experience the wearing comfort as pleasant³
- Increased mobility: possibility of wearing regular footwear
- Promotes self-management thanks to easy handling¹

Adjustable compression

20 – 30 mmHg
30 – 40 mmHg
40 – 50 mmHg

Product benefits

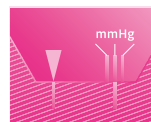

Built-In-Pressure®



Variety



Juxtaposed band



Easy handling



Inelastic



Breathe-O-Prene



Colours



S = Standard

Note

For more information and handling videos please visit:
medi.biz/jl

* Please consider, that this recommendation does not replace the diagnosis and consultation of a medical healthcare professional.

Studies

¹ Mosti G et al. Adjustable compression wrap devices are cheaper and more effective than inelastic bandages for venous leg ulcer healing. A Multicentric Italian Randomized Clinical Experience. *Phlebology* 2020;35(2):124-133.

² Stather PW et al. Review of adjustable velcro wrap devices for venous ulceration. In *Wound J* 2019;16(4):903-908.

³ Protz K et al. Comparison of handling, pressure and wearing comfort of different compression edvices for decongestion therapy. *Veins and Lymphatics* 2018;7:7989:137-138.

circaid® juxtalite® hd

Your order includes

- 1 inelastic adjustable compression garment
- 1 circaid Built-In-Pressure System (BPS) guide card
- 1 pair of circaid compressive undersocks moderate



circaid juxtalite hd

		Short	Long
Size / Art. No.	S	JU1H702000	JU1H002000
	M	JU1H703000	JU1H003000
	M-X	JU1H713000	JU1H013000
	L	JU1H704000	JU1H004000
	L-X	JU1H714000	JU1H014000
	XL	JU1H705000	JU1H005000
	XL-X	JU1H715000	JU1H015000
	XXL	JU1H706000	JU1H006000

Measurement chart

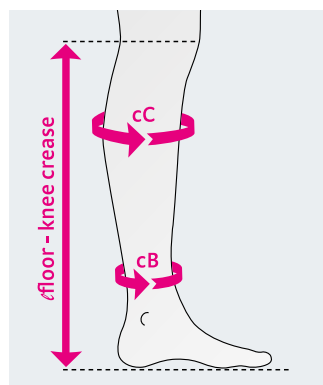

Circumferences in cm	S	M	M - X	L
cC	26 - 36	33 - 44	44 - 54	41 - 51
cB	19 - 22	22 - 27	22 - 27	25 - 32
	L - X	XL	XL - X	XXL
cC	51 - 61	37 - 48	48 - 61	53 - 64
cB	25 - 32	30 - 37	30 - 37	35 - 42
Sizing measurement in cm	Short	Long		
∠ floor - knee crease	< 44	> 44		

circaid[®] foot options

The following foot options are recommended to wear in combination with circaid juxtalite.

Note

It is recommended to always wear a circaid foot option in combination with a circaid leg garment. The indications of the circaid foot options are identical to the indications of the corresponding circaid leg garment. Please order separately.

circaid[®] compression anklet

Standard compression option for foot and ankle.

Product details

- Provides compression to the foot and ankle
- Can be combined with other circaid foot options
- Available in standard and large



circaid compression anklet

Measurement chart

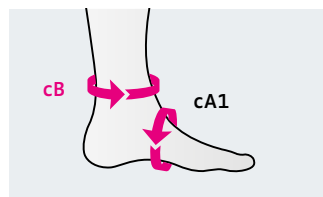

Circumferences in cm	Standard	Large
cB	19 – 27	25 – 50
cA1	19 – 36	22 – 41
Art. No.	JU51001000	JU51002000

circaid[®] juxtalite[®] ankle foot wrap

Additional compression for the foot.

Product details

- Provides additional compression to foot and ankle
- Instantly adjustable
- Can be trimmed to provide the perfect fit
- Available in 2 sizes (S, M)



circaid juxtalite ankle foot wrap

Measurement chart

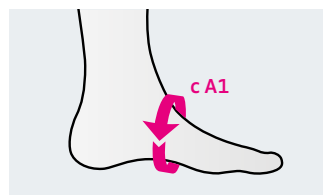

Circumference in cm	S	M
cA1	19 – 26	24 – 31
Art. No.	JU1W002000	JU1W003000

circaid® power added compression band (pac band)

Additional, customisable compression option for the foot.

Product details

- Provides additional compression to the arch of the foot and around the malleoli
- Used in combination with the circaid compression anklet
- Can be trimmed to fit almost every foot shape
- Available in standard, large and extra large
- Bilateral use (left or right foot)



circaid power added compression band (pac band)

Measurement chart

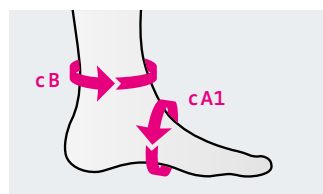

Circumferences in cm	Standard	Large	Extra Large
cB	19 – 27	25 – 50	45 – 56
cA1	19 – 36	22 – 41	22 – 41
Art. No.	JU5P001000	JU5P002000	JU5P003000

circaid® compressive undersock

Easy-to-apply liner with targeted compression for foot and ankle.

Product details

- Applies graduated compression to the foot and ankle
- Graduated compression continues into the leg portion of the undersock
- Soft material for pleasant wearing comfort
- Available in 15 – 25 mmHg (moderate compression) and 25 – 35 mmHg (firm compression)
- Available in standard and large



circaid compressive undersock

Measurement chart

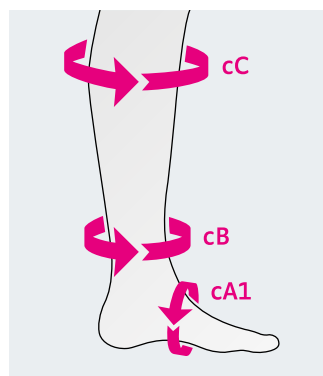

	Standard	Large
cC	26 – 54	41 – 64
cB	19 – 27	25 – 42
cA1	19 – 32	24 – 41

Size	Strength	Art. No.
Standard	Moderate	JU5M001000
Large	Moderate	JU5M002000
Standard	Firm	JU5F001000
Large	Firm	JU5F001000

circaid® toe cap

Additional compression for the toes.

Product details

- Provides light to moderate compression
- Individually adjustable length of the toes
- Designed for left or right limb use
- It is recommended to always wear the circaid toe cap with a circaid foot option



circaid toe cap

Measurement chart

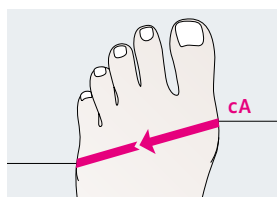

Circumference in cm	2	3	4	5	6
cA	20 – 22	22 – 24	24 – 26	26 – 28	28 – 30
Art. No.	JU5T002000	JU5T003000	JU5T004000	JU5T005000	JU5T006000

circaid® accessories

circaid® liner

Additional wearing comfort.

- Can be worn directly against the skin underneath circaid products
- Extra comfort
- Note: does not provide therapeutic compression

Article	Art. No.	Size
Undersleeve	JULS709000	One size



circaid liner

medi Therapy Concept Lymphology

Effective lymphoedema treatment.

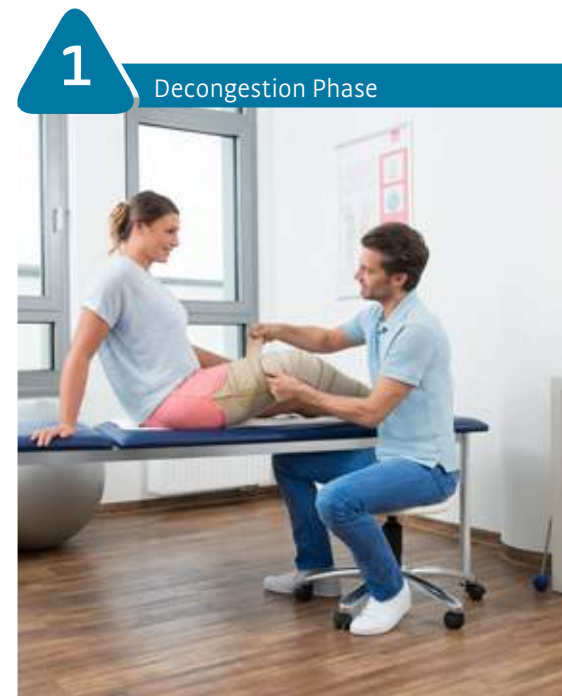
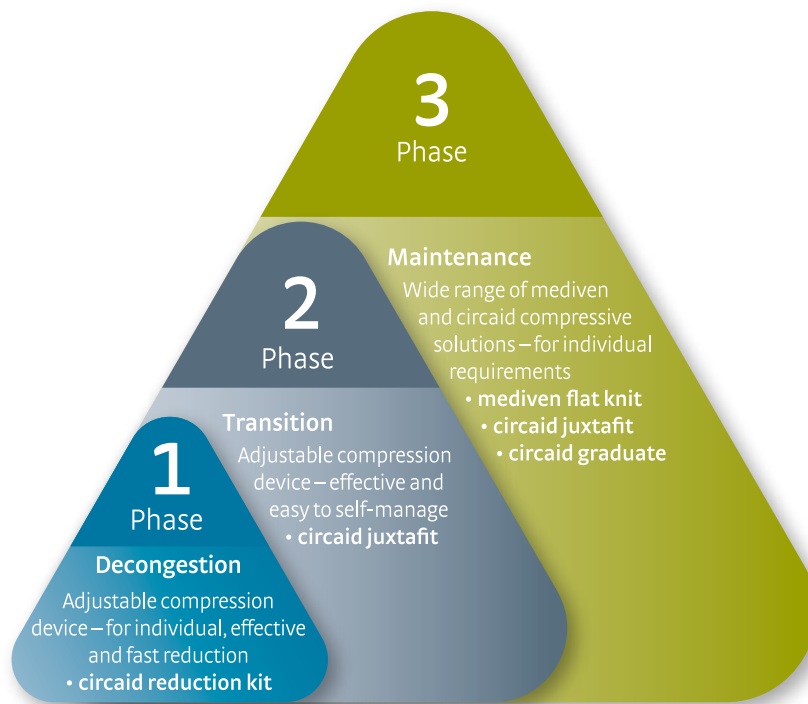

Adjustable and patient-individual compression for initial oedema reduction.

• **circaid® reduction kit**

2

Transition Phase



Effective compression to optimise reduction results.

- **circaid® juxtafit®**

3

Maintenance Phase



A huge variety of compression solutions to maintain therapy results in the long term.

- **mediven® flat knit**
- **circaid® juxtafit®**

medi. I feel better.



1
Phase



circaid® reduction kit leg

Customisable, adjustable compression device for the decongestion phase of leg lymphoedema.

medi tip*:

Due to product features we recommend circaid reduction kit for:

- Men / women
- Initial decongestion of leg lymphoedema
- Up to 24 hour compression therapy

Incidations

- Lymphoedema
- Other forms of oedema

Product features

- Easy and time saving handling – simple donning and doffing
- Adjustable sizes – garment is initially fitted to the patient’s individual circumferences and limb shape
- Ability to reduce size of garment as the limb volume decreases
- Built-In-Tension System (BTS) to set, control and re-adjust the correct therapeutic tension level – enables consistent compression and effective decongestion
- Re-adjusting the individual bands avoids pressure loss and thus sliding down of the garment – supporting oedema reduction effectively^{1,2}
- Breathe-O-Prene: breathable and inelastic material with high wall-stability for high working pressure
- Latex-free, odour-inhibiting material with anti-bacterial effect

Benefits

- Easy handling – time-saving and less susceptible to error³
- Compression therapy – essential part of the complex lymphoedema therapy
- Faster reduction of lymphoedema⁴
- Increased patient-adherence: 94.6 % of the users experience the wearing comfort as pleasant³
- Promotes self-management thanks to easy handling

Adjustable compression

Tension 1 – 8

Product benefits



Juxtaposed band



Variety



Easy handling



Inelastic

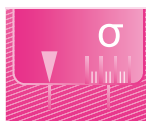

Built-In-Tension



Breathe-O-Prene



Colours



S = Standard

Note

A video for application and customisation of the circaid reduction kit can be found here: [medi.biz/rk](https://www.medi.biz/rk)

*Please consider, that this recommendation does not replace the diagnosis and consultation of a medical healthcare professional.

Studies

¹Mosti G et al. Adjustable compression wrap devices are cheaper and more effective than inelastic Bandages for venous leg ulcer healing. A Multicentric Italian Randomized Clinical Experience. Phlebology 2019. DOI: 10.1177/0268355519858439; Epub ahead of print.

²Stather PW et al. Review of adjustable velcro wrap devices for venous ulceration. In Wound J 2019. DOI: 10.1111/iwj.13116; Epub ahead of print.

³Protz K et al. Comparison of handling, pressure and wearing comfort of different compression devices for decongestion therapy. Veins and Lymphatics 2018;7:7989:137-138.

⁴Damstra R et al. Prospective, randomized, controlled trial comparing the effectiveness of adjustable compression Velcro wraps versus inelastic multicomponent compression bandages in the initial treatment of leg lymphedema. Journal of Vascular Surgery: Venous and Lymphatic Disorders 2013;1(1):13-9.



circaid reduction kit lower leg

circaid® reduction kit lower leg

Art. No.	Description
JV23101000	circaid reduction kit lower leg short
JV23111000	circaid reduction kit lower leg short wide
JV23201000	circaid reduction kit lower leg standard
JV23211000	circaid reduction kit lower leg standard wide
JV23301000	circaid reduction kit lower leg long
JV23311000	circaid reduction kit lower leg long wide

Circumferences in cm	Standard	Wide
cC*	< 65	< 85
cB	< 55	< 65

Length measurement in cm	Short	Standard	Long
l malleolus – knee crease	< 32	32 – 36	> 36

*cC should not be more than 30cm bigger than cB.

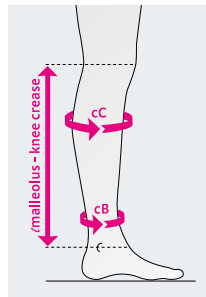

Your order for circaid reduction kit lower leg includes:

- 1 adjustable compression device
- 1 Built-In-Tension System (BTS) guide card
- 1 pair of circaid undersleeves leg
- 1 circaid shelf strap with 6 hook tabs
- 6 hook and loop fasteners
- 1 paper measurement tape



circaid reduction kit knee

circaid® reduction kit knee

Art. No.	Description
JV21101000	circaid reduction kit knee standard
JV32001000	circaid reduction kit knee spine

Circumferences in cm	Standard
cE2*	< 110
cE	< 102
cC	< 80

Length in cm	Standard
lC – E2	30

*cE2 should not be more than 30 cm bigger than cC. cE2 is 10 cm above the knee

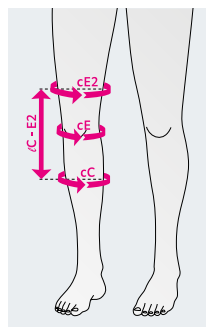

Your order for circaid reduction kit knee includes:

- 1 adjustable compression device
- 2 circaid knee spine (connection piece)
- 1 circaid shelf strap with 6 hook tabs
- 1 paper measurement tape



circaid reduction kit upper leg

circaid® reduction kit upper leg

Art. No.	Description
JV22101000	circaid reduction kit upper leg short
JV22111000	circaid reduction kit upper leg short wide
JV22201000	circaid reduction kit upper leg standard
JV22211000	circaid reduction kit upper leg standard wide

Circumferences in cm	Standard	Wide
cG*	< 80	< 125
cE2**	< 65	< 110
Length measurement in cm	Short	Standard
∠knee crease – K1	< 37	37 – 41

*cG should not be 30 cm bigger than cE2

**cE2 is 10 cm above the knee

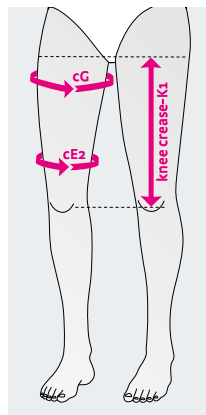

Your order for circaid reduction kit upper leg includes:

- 1 adjustable compression device
- 1 Built-In-Tension System (BTS) guide card
- 1 circaid shelf strap with 6 hook tabs
- 6 hook and loop fasteners
- 1 paper measurement tape

Note

A foot option has to be ordered separately.



circaid reduction kit combination of upper leg, knee, lower leg and foot option



Built-In-Tension System (BTS) guide card



Fitting of the lower leg

circaid[®] foot options

The following foot options are recommended to wear in combination with circaid reduction kit.

Note

It is recommended to always wear a circaid foot option in combination with a circaid leg garment. The indications of the circaid foot options are identical to the indications of the corresponding circaid leg garment. Please order separately.

circaid[®] power added compression band (pac band)

Additional compression for the arch of the foot and ankle.

Product details

- Additional compression to the foot with mild to severe tendency for oedema
- Targets the arch of the foot and around the malleoli
- Can be trimmed to fit almost every foot shape
- Easy handling
- Lightweight and breathable material
- Available in standard, large and extra large
- Bilateral use (left or right foot)



circaid pac band

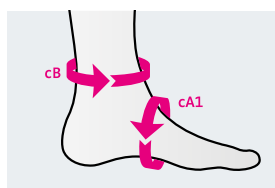

Circumferences in cm	Standard	Large	Extra Large
cB	19 – 27	25 – 50	45 – 56
cA1	19 – 36	22 – 41	22 – 41
Art. No.	JU5P001000	JU5P002000	JU5P003000

circaid[®] customizable interlocking ankle foot wrap

Customisable foot option for oedema decongestion.

Product details

- Customisable to patient-individual circumferences and shape
- Adjustable to reducing circumferences during decongestion
- Interlocking heel band for foot length adjustment
- Heel band offers targeted compression to the Bisgaard's region and ankle
- Easy handling
- One size fits all



circaid customizable interlocking ankle foot wrap

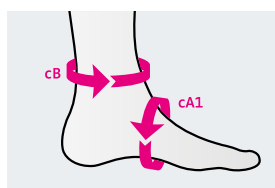

Circumferences in cm	
cB	< 56
cA1	< 44
Art. No.	JU5S001000

circaid® toe cap

Additional compression for the toes.

Product details

- Provides light to moderate compression
- Individually adjustable length of the toes
- Designed for left or right limb use
- It is recommended to always wear the circaid toe cap with a circaid foot option



circaid toe cap

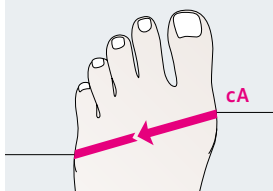

Circumference in cm	2	3	4	5	6
cA	20–22	22–24	24–26	26–28	28–30
Art. No.	JU5T002000	JU5T003000	JU5T004000	JU5T005000	JU5T006000

Tip

Video for application and customisation of the circaid foot options can be found here: [medi.biz/rk](https://www.medi.biz/rk)

circaid® reduction kit accessories

Additional accessories for the leg.

circaid® reduction kit undersleeve leg

Additional wearing comfort.

- Can be worn directly against the skin underneath circaid products
- Extra comfort
- Note: does not provide therapeutic compression

Art. No.	Description
JXLS015000	circaid undersleeve whole leg cotton
JXLSS24000	circaid undersock lower leg cotton extra wide
JXLSS36000	circaid undersock whole leg cotton extra wide



circaid undersleeve whole leg

Note

It is recommended to always use a circaid supporting band in combination with a circaid garment. The indications of the circaid supporting bands are identical to the indications of the corresponding circaid garment. Please order separately.

circaid® reduction kit shelf strap

Additional support.

- Offers additional support and coverage
- Covers potential gaps that may appear

Art. No.	Description
JV33001000	circaid reduction kit shelf strap customizable



circaid reduction kit shelf strap

circaid® reduction kit lobe lifter

Additional compression and coverage for extreme lobules.

- Offers additional support and coverage
- Customisable for patients´ individual needs

Art. No.	Description
JV33002000	circaid reduction kit lobe lifter



circaid reduction kit lobe lifter





circaid[®] reduction kit arm

Customisable, adjustable compression device for the decongestion phase of arm lymphoedema.

medi tip*:

Due to product features we recommend circaid reduction kit for:

- Men / women
- Initial decongestion of arm lymphoedema
- Up to 24 hour compression therapy

Indications

- Lymphoedema
- Other forms of oedema

Product features

- Easy and time saving handling – simple donning and doffing
- Adjustable sizes – garment is initially fitted to the patient’s individual circumferences and limb shape
- Ability to reduce size of garment as the limb volume decreases
- Built-In-Tension System (BTS) to set, control and re-adjust the correct therapeutic tension level – enables consistent compression and effective decongestion
- Re-adjusting the individual bands avoids pressure loss and thus sliding down of the garment – supporting oedema reduction effectively
- Breathe-O-Prene: breathable and inelastic material with high wall-stability for high working pressure
- Latex-free, odour-inhibiting material with anti-bacterial effect
- Can also be worn at night if required

Benefits

- Easy handling – time-saving and less susceptible to error
- Easy handling – can be applied using one hand
- Compression therapy – essential part of the complex lymphoedema therapy¹
- Faster reduction of lymphoedema²
- Promotes self-management thanks to easy handling

Adjustable compression

Tension 1 – 8

Product benefits



Juxtaposed band



Variety



Easy handling



Inelastic

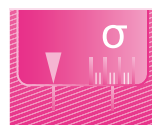

Built-In-Tension



Breathe-O-Prene



Colours

Beige
S

S = Standard

Note

A video for application and customisation of the circaid reduction kit arm can be found here: [medi.biz/rk](https://www.medi.biz/rk)

*Please consider, that this recommendation does not replace the diagnosis and consultation of a medical healthcare professional.

Studies

¹ Lymphoedema Framework. Best Practice for the Management of Lymphoedema. International consensus. London: MEP Ltd, 2006.

² Damstra R et al. Prospective, randomized, controlled trial comparing the effectiveness of adjustable compression Velcro wraps versus inelastic multicomponent compression bandages in the initial treatment of leg lymphedema. Journal of Vascular Surgery: Venous and Lymphatic Disorders 2013;1(1):13-9.

circaid® reduction kit arm

Art. No.	Description	
JV11001000	circaid reduction kit arm standard	
JV11011000	circaid reduction kit arm standard wide	
JV12001000	circaid reduction kit arm long	
JV12011000	circaid reduction kit arm long wide	
Circumferences in cm	Standard	Wide
cF	< 50	50 – 65
cB*	< 30	< 30
Length measurement in cm	Standard	Long
cC – G	< 45	> 45

* If cB is > 30 cm hand wrap will not fit, though circaid reduction kit arm component may still be used.



circaid reduction kit arm

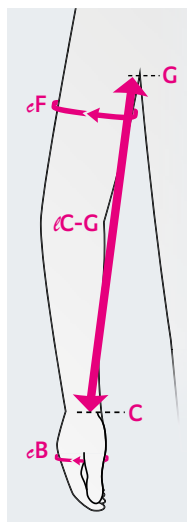

Your order for circaid reduction kit arm includes:

- 1 adjustable compression device
- 1 Built-In-Tension System (BTS) guide card
- 1 circaid customizable hand wrap
- 1 pair of circaid undersleeve arm
- 1 paper measurement tape



circaid reduction kit arm including circaid customizable hand wrap



Built-In-Tension System (BTS) guide card



Fitting of the arm component

circaid® hand options & accessories

The following hand options are recommended to wear in combination with circaid reduction kit.

Note

It is recommended to always wear a circaid hand option in combination with a circaid arm garment. The indications of the circaid foot options are identical to the indications of the corresponding circaid leg garment. Please order separately.

Tip

Video for application and customisation of the circaid hand options can be found here: [medi.biz/rk](https://www.medi.biz/rk)

circaid® customizable hand wrap

Customisable hand option for oedema decongestion.

Product details

- Provides additional compression to the hand from the wrist to the base of the fingers
- Customisable to patient individual circumferences and shape
- Adjustable to decreasing circumferences during decongestion
- Easy handling
- Bilateral use (left and / or right hand)



circaid customizable interlocking hand wrap

Art. No.	Description	Circumferences in cm	
JULV409000	circaid customizable hand wrap	cC	< 30
		cB	< 30

circaid® glove

Additional compression for the fingers.

Product details

- Provides light to moderate compression
- Individually adjustable length of the fingers
- Intuitive and simple donning
- Designed for left or right hand use
- It is recommended to always wear the circaid glove with a circaid arm garment



circaid glove

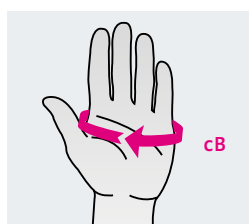

Circumference in cm	2	3	4	5	6
cB	18 – 21	20 – 23	22 – 25	24 – 27	26 – 29
Art. No.	JU5G002000	JU5G003000	JU5G004000	JU5G005000	JU5G006000

circaid® reduction kit undersleeve arm

Additional wearing comfort.

- Can be worn directly against the skin underneath circaid products
- Extra comfort
- Note: does not provide therapeutic compression

Art. No.	Description
JULV909000	circaid reduction kit undersleeve arm wide



circaid reduction kit undersleeve arm

2
Phase

3
Phase



circaid® juxtafit® premium leg

Premium adjustable compression device for optimising and maintaining decongestion results in lymphoedema treatment.

medi tip*:

Due to product features we recommend circaid juxtafit for:

- Men / women
- Optimising and maintaining decongestion results
- Patients who have challenges with medical compression stockings
- Up to 24 hour compression therapy
- Mobile / immobile patients

Indications

- Lymphoedema
- Other forms of oedema
- Lipoedema

Product features

- High quality band fasteners with reinforced landing straps
- Easy handling – simple donning and doffing
- circaid Built-In-Pressure System (BPS): adjustable, controllable and re-adjustable compression
- Re-adjusting the individual bands avoids pressure loss and thus sliding down of the garment
- **New:** Also available with compressive undersock moderate
 - Applies graduated compression to the foot and ankle
 - Graduated compression continues into the leg portion of the undersock
- Breathe-O-Prene: breathable and inelastic material with high wall-stability for high working pressure
- Latex-free, odour-inhibiting material with anti-bacterial effect
- Features for upper leg: Smooth material in the back of the knee – for more wearing comfort
- Also available as made-to-measure
- Twelve month lifespan

Benefits

- Offering an alternative therapy solution for patients who are not able to apply or tolerate medical compression stockings
- Compression therapy – essential part of the complex lymphoedema therapy¹
- Increased patient-adherence: 94.6 % of the users experience the wearing comfort as pleasant²
- Increased mobility: possibility of wearing regular footwear²
- Easy handling allows for self-management of the patient

Adjustable compression

20 – 30 mmHg
30 – 40 mmHg
40 – 50 mmHg
50+ mmHg

Product benefits

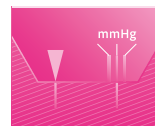

Built-In-Pressure



Variety



Juxtaposed band



Easy handling



Inelastic



Breathe-O-Prene



Colours

Beige
S + M

S = Standard

M = Made-to-measure

Note

A video for application of the circaid juxtafit can be found here: [medi.biz/jf](https://www.medi.biz/jf)

*Please consider, that this recommendation does not replace the diagnosis and consultation of a medical healthcare professional.

Studies



¹ Lymphoedema Framework. Best Practice for the Management of Lymphoedema. International consensus. London: MEP Ltd, 2006.

² Protz K et al. Comparison of handling, pressure and wearing comfort of different compression edvices for decongestion therapy. Veins and Lymphatics 2018;7:7989:137-138.



circaid juxtafit premium lower leg

circaid® juxtafit® premium lower leg standard styles

	BD		BD	
				
Size / Art. No.	Short		Long	
S	JU35702000		JU35002000	
M	JU35703000		JU35003000	
L	JU35704000		JU35004000	
XL	JU35705000		JU35005000	
XXL	JU35706000		JU35006000	
M extra wide	JU35713000		JU35013000	
L extra wide	JU35714000		JU35014000	
XL extra wide	JU35715000		JU35015000	
Circumferences in cm	S	M	M – X	L
cC	30 – 38	36 – 43	43 – 50	41 – 48
cB1	20 – 28	25 – 33	33 – 40	30 – 38
cB	15 – 23	20 – 28	20 – 28	25 – 33
	L – X	XL	XL – X	XXL
cC	48 – 56	41 – 51	51 – 61	53 – 64
cB1	38 – 46	33 – 41	41 – 51	43 – 53
cB	25 – 33	30 – 38	30 – 38	33 – 41
Length measurement in cm	Short		Long	
∠malleolus – knee crease	< 36		> 36	

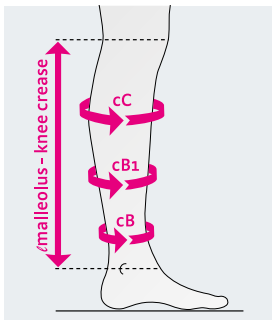

Your order for circaid juxtafit premium lower leg includes:

- 1 adjustable compression device
- 1 circaid Built-In-Pressure System (BPS) guide card
- 1 pair of circaid compression anklets
- 1 circaid power added compression band (pac band)
- 1 pair of circaid undersleeves lower leg silver
- 1 circaid cover up



circaid juxtafit premium lower leg



circaid juxtafit premium lower leg (readjustment)





circaid juxtafit premium lower leg band fasteners with landing straps



circaid juxtafit premium lower leg with circaid compressive undersock

circaid® juxtafit® premium lower leg with circaid® compressive undersock standard styles

	BD		BD	
				
Size / Art. No.	Short	Long		
S	JU3M702000	JU3M002000		
M	JU3M703000	JU3M003000		
L	JU3M704000	JU3M004000		
XL	JU3M705000	JU3M005000		
XXL	JU3M706000	JU3M006000		
M extra wide	JU3M713000	JU3M013000		
L extra wide	JU3M714000	JU3M014000		
XL extra wide	JU3M715000	JU3M015000		
Circumferences in cm	S	M	M – X	L
cC	30 – 38	36 – 43	43 – 50	41 – 48
cB1	20 – 28	25 – 33	33 – 40	30 – 38
cB	15 – 23	20 – 28	20 – 28	25 – 33
	L – X	XL	XL – X	XXL
cC	48 – 56	41 – 51	51 – 61	53 – 64
cB1	38 – 46	33 – 41	41 – 51	43 – 53
cB	25 – 33	30 – 38	30 – 38	33 – 41
Length measurement in cm	Short		Long	
∠malleolus – knee crease	< 36		> 36	

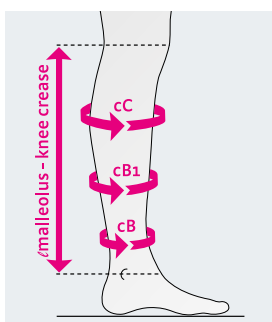









Your order for circaid juxtafit premium lower leg with circaid compressive undersock includes:

- 1 adjustable compression device
- 1 circaid Built-In-Pressure System (BPS) guide card
- 1 pair of circaid compressive undersocks moderate
- 1 circaid power added compression band (pac band)
- 1 circaid cover up



circaid juxtafit premium whole leg

circaid® juxtafit® premium leg made-to-measure styles

BD	AD	BF	AF	BC
				
lower leg	lower leg with attached ankle foot wrap	lower leg with knee	lower leg with knee and attached ankle foot wrap	whole leg
AG	DF	DG	EG	
				
whole leg with attached ankle foot wrap	knee	upper leg with knee	upper leg	

Your order for circaid juxtafit premium leg includes:

- 1 adjustable compression device
- 1 circaid Built-In-Pressure System (BPS) guide card
- 1 pair of circaid compression anklets
- 1 circaid power added compression band (pac band)
- 1 pair of circaid undersleeves lower leg silver
- 1 circaid cover up

circaid juxtafit premium is available with the following foot options:

- circaid juxtafit premium ankle foot wrap, MTM* separate
- circaid juxtafit premium ankle foot wrap, MTM* attached
- circaid juxtafit premium ankle foot wrap, standard
- circaid power added compression band (pac band)
- circaid juxtafit premium interlocking ankle foot wrap
- circaid single band ankle foot wrap

Please select accordingly when placing your order.

*MTM = made-to-measure



2

Phase

3

Phase



circaid® juxtafit® essentials leg

Ready-to-wear adjustable compression device for optimising and maintaining decongestion results in lymphoedema treatment.

medi tip*:

Due to product features we recommend circaid juxtafit for:

- Men / women
- Optimising and maintaining decongestion results
- Patients who have challenges with medical compression stockings
- Up to 24 hour compression therapy
- Mobile / immobile patients

Indications

- Lymphoedema
- Other forms of oedema
- Lipoedema

Product features

- Easy handling – simple donning and doffing
- circaid Built-In-Pressure System (BPS): adjustable, controllable and re-adjustable compression
- Re-adjusting the individual bands avoids pressure loss and thus sliding down of the garment
- Sustained compression with defined pressure for up to 24 hours if required
- Breathe-O-Prene: breathable and inelastic material with high wall-stability for high working pressure
- Latex-free, odour-inhibiting material with anti-bacterial effect
- Features for upper leg with knee
 - Smooth material in the back of the knee – for more wearing comfort
 - Garment straps can be trimmed for better handling and wearing comfort
 - Garment can be trimmed in length for an optimum fit
- **New:** Also available with compressive undersock moderate
 - Applies graduated compression to the foot and ankle
 - Graduated compression continues into the leg portion of the undersock
- Available in standard sizes only
- Six month lifespan

Benefits

- Offering an alternative therapy solution for patients who are not able to apply or tolerate compression stockings
- Compression therapy – essential part of the complex lymphoedema therapy¹
- Increased patient-adherence: 94.6 % of the users experience the wearing comfort as pleasant²
- Increased mobility: possibility of wearing regular footwear
- Easy handling allows for self-management of the patient

Adjustable compression

20 – 30 mmHg
30 – 40 mmHg
40 – 50 mmHg
50+ mmHg

Product benefits

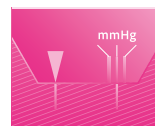

Built-In-Pressure



Variety



Juxtaped band



Easy handling



Inelastic



Breathe-O-Prene



Colours



S = Standard

Note

A video for application of the circaid juxtafit can be found here: [medi.biz/jf](https://www.medi.biz/jf)

* Please consider, that this recommendation does not replace the diagnosis and consultation of a medical healthcare professional.

Studies



¹ Lymphoedema Framework. Best Practice for the Management of Lymphoedema. International consensus. London: MEP Ltd, 2006.

² Protz K et al. Comparison of handling, pressure and wearing comfort of different compression edives for decongestion therapy. Veins and Lymphatics 2018;7:7989:137-138.



circaid juxtafit essentials lower leg

circaid® juxtafit® essentials lower leg standard styles

	BD		BD	
				
Size / Art. No.	Short		Long	
S	JU25702000		JU25002000	
M	JU25703000		JU25003000	
L	JU25704000		JU25004000	
XL	JU25705000		JU25005000	
XXL	JU25706000		JU25006000	
M extra wide	JU25713000		JU25013000	
L extra wide	JU25714000		JU25014000	
XL extra wide	JU25715000		JU25015000	
Circumferences in cm	S	M	M – X	L
cC	30 – 38	36 – 43	43 – 50	41 – 48
cB1	20 – 28	25 – 33	33 – 40	30 – 38
cB	15 – 23	20 – 28	20 – 28	25 – 33
	L – X	XL	XL – X	XXL
cC	48 – 56	41 – 51	51 – 61	53 – 64
cB1	38 – 46	33 – 41	41 – 51	43 – 53
cB	25 – 33	30 – 38	30 – 38	33 – 41
Length measurement in cm	Short		Long	
∠ malleolus – knee crease	< 36		> 36	

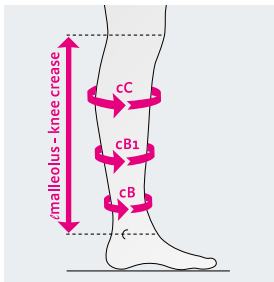

Your order for circaid juxtafit essentials lower leg includes:

- 1 adjustable compression device
- 1 circaid Built-In-Pressure System (BPS) guide card
- 1 pair of circaid compression anklets
- 1 circaid power added compression band (pac band)
- 1 pair of circaid undersleeves lower leg standard
- 1 circaid cover up



circaid juxtafit essentials combination, circaid juxtafit essentials upper leg with knee, lower leg and foot option (pac band)



circaid juxtafit essentials lower leg with pac band





circaid juxtafit essentials lower leg band fasteners



circaid juxtafit essentials lower leg with circaid compressive undersock

circaid® juxtafit® essentials lower leg with circaid® compressive undersock standard styles

	BD		BD	
				
Size / Art. No.	Short	Long		
S	JU2M702000	JU2M002000		
M	JU2M703000	JU2M003000		
L	JU2M704000	JU2M004000		
XL	JU2M705000	JU2M005000		
XXL	JU2M706000	JU2M006000		
M extra wide	JU2M713000	JU2M013000		
L extra wide	JU2M714000	JU2M014000		
XL extra wide	JU2M715000	JU2M015000		
Circumferences in cm	S	M	M – X	L
cC	30 – 38	36 – 43	43 – 50	41 – 48
cB1	20 – 28	25 – 33	33 – 40	30 – 38
cB	15 – 23	20 – 28	20 – 28	25 – 33
	L – X	XL	XL – X	XXL
cC	48 – 56	41 – 51	51 – 61	53 – 64
cB1	38 – 46	33 – 41	41 – 51	43 – 53
cB	25 – 33	30 – 38	30 – 38	33 – 41
Length measurement in cm	Short	Long		
∠ malleolus – knee crease	< 36	> 36		

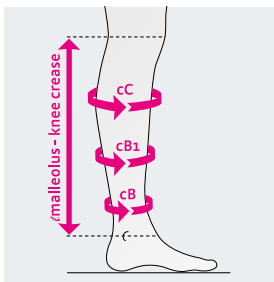

Your order for circaid juxtafit essentials lower leg includes:

- 1 adjustable compression device
- 1 circaid Built-In-Pressure System (BPS) guide card
- 1 pair of circaid compressive undersocks
- 1 circaid power added compression band (pac band)
- 1 circaid cover up



circaid juxtafit essentials upper leg with knee

circaid® juxtafit® essentials upper leg with knee standard styles

		DG	DG	DG			
Size / Art. No.		Extra short	Short	Long			
Left	XXS	JU2878X000	JU2873X000	JU2803X000			
	XS	JU28781000	JU28731000	JU28031000			
	S	JU28782000	JU28732000	JU28032000			
	M	JU28783000	JU28733000	JU28033000			
	L	JU28784000	JU28734000	JU28034000			
	XL	JU28785000	JU28735000	JU28035000			
Right	XXS	JU2879X 000	JU2874X000	JU2804X000			
	XS	JU28791000	JU28741000	JU28041000			
	S	JU28792000	JU28742000	JU28042000			
	M	JU28793000	JU28743000	JU28043000			
	L	JU28794000	JU28744000	JU28044000			
	XL	JU28795000	JU28745000	JU28045000			
Circumferences in cm		XXS	XS	S	M	L	XL
cG		40 – 52	46 – 62	54 – 70	60 – 80	69 – 90	77 – 101
cE1*		32 – 42	37 – 48	42 – 55	50 – 65	58 – 76	66 – 87
cD		23 – 30	27 – 35	31 – 41	35 – 46	40 – 52	44 – 58
Length measurement in cm		Extra short	Short	Long			
knee crease – K1		< 25	25 – 35	> 35			

*cE1 is 5 cm above the patella
product length can be shortened by 5 cm

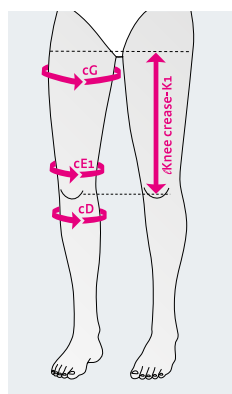

Your order for circaid juxtafit essentials upper leg with knee includes:

- 1 adjustable compression garment upper leg
- 1 circaid Built-In-Pressure System (BPS) guide card
- 1 pair of circaid undersleeves whole leg
- 1 circaid cover up



circaid® foot options

The following foot options are recommended to wear in combination with circaid juxtafit.

Note:

It is recommended to always wear a circaid foot option in combination with a circaid leg garment. The indications of the circaid foot options are identical to the indications of the corresponding circaid leg garment. Please order separately.

circaid® power added compression band (pac band)

Additional compression for the arch of the foot and ankle.

Product details

- Additional compression to the foot with mild to severe tendency for oedema
- Targets the arch of the foot and around the malleoli
- Can be trimmed to fit almost every foot shape
- Easy handling
- Lightweight and breathable material
- Available in standard, large and extra large
- Bilateral use (left or right foot)

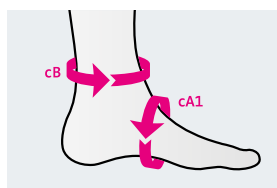

Circumferences in cm	Standard	Large	Extra Large
cB	19 – 27	25 – 50	45 – 56
cA1	19 – 36	22 – 41	22 – 41
Art. No.	JU5P001000	JU5P002000	JU5P003000



circaid power added compression band (pac band)

circaid® toe cap

Additional compression for the toes.

Product details

- Provides light to moderate compression
- Individually adjustable length of the toes
- Designed for left or right limb use
- It is recommended to always wear the circaid toe cap with a circaid foot option

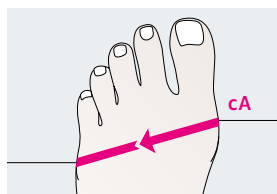

Circumference in cm	2	3	4	5	6
cA	20 – 22	22 – 24	24 – 26	26 – 28	28 – 30
Art. No.	JU5T002000	JU5T003000	JU5T004000	JU5T005000	JU5T006000



circaid toe cap

circaid® juxtafit® premium ankle foot wrap

Adjustable compression device for the foot with closed heel.

Product details

- Provides compression to the foot and ankle
- High quality band fasteners with reinforced landing straps
- Easy handling
- Can be trimmed in length to provide perfect fit
- Available in standard sizes and as made-to-measure

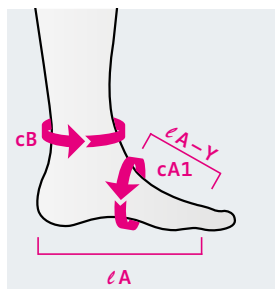

Measurements in cm	S	M	L
lA-Y	> 9	> 9	> 9
cB	< 36	< 36	< 41
cA1	19 – 24	24 – 29	29 – 34
lA	> 16	> 16	> 16
Art. No.	JU3W002000	JU3W003000	JU3W004000



circaid juxtafit premium ankle foot wrap

circaid® juxtafit® premium interlocking ankle foot wrap

Adjustable compression device for the foot and heel with foot length adjustment.

Product details

- Provides compression to the foot and ankle
- Interlocking heel band allows foot length adjustment
- High quality band fasteners with reinforced landing straps
- Heel band offers targeted compression to the Bisgaard's region and ankle
- Easy handling
- Available in standard sizes only

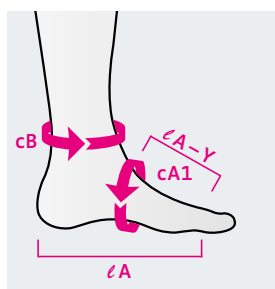

Measurements in cm	S	M	L
lA-Y	> 9	> 9	> 9
cB	< 36	< 36	< 41
cA1	19 – 24	24 – 29	29 – 34
lA	13 – 25	13 – 25	13 – 25
Art. No.	JU3I002000	JU3I003000	JU3I004000



circaid juxtafit premium interlocking ankle foot wrap

circaid® single band ankle foot wrap

Additional compression for the arch of the foot and ankle.

Product details

- Provides compression to foot and ankle
- Suitable for most foot sizes and shapes
- Ideal for individual bandaging of the foot
- One size fits all

Measurements

Width	7,6 cm
Length	203 cm
Art. No.	JU5Q001000



circaid single band ankle foot wrap

circaid® compression anklet

Standard compression option for foot and ankle.

Product details

- Provides compression to the foot and ankle
- Can be combined with other circaid foot options
- Available in standard and large

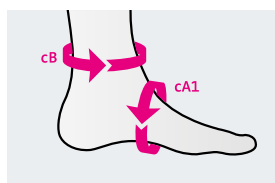

Circumferences in cm	Standard	Large
cB	19 – 27	25 – 50
cA1	19 – 36	22 – 41
Art. No.	JU51001000	JU51002000

Tip

Video for application and customisation of the circaid foot options can be found here: [medi.biz/jf](https://www.medi.biz/jf)



circaid compression anklet



circaid® juxtafit® accessories

circaid® undersleeves

For whole leg and lower leg.

- Can be worn directly against the skin underneath circaid products to provide added comfort
- Note: does not provide therapeutic compression

Leg versions

- circaid undersleeves (without foot)
 - lower leg
 - whole leg
 - lower leg, silver
 - whole leg, silver
- circaid undersock (with foot)
 - lower leg
 - whole leg
 - lower leg, silver
 - whole leg, silver
 - lower leg cotton
(extra thick for maximum comfort)
 - whole leg cotton
(extra thick for maximum comfort)



circaid undersleeve lower leg, silver



circaid undersock whole leg with foot

Standard size	Art. No.	Type	Style
Undersleeve lower leg	JULS709000		BD
	JUSS709000	Silver	BD
Undersleeve whole leg	JULS009000		BC
	JUSS009000	Silver	BC
Undersock lower leg	JULT709000		AD
	JUST709000	Silver	AD
	JUCT709000	Cotton	AD
Undersock whole leg	JULT009000		AG
	JUST009000	Silver	AG
	JUCT009000	Cotton	AG

circaid® cover up

Silky oversleeve for circaid garments.

- Can be worn over circaid arm and leg garments
- Prevents the garments from snagging on clothing or bedding
- Gives adjustable compression garments a refined look
- Available in black and beige
- Note: does not provide therapeutic compression

Standard size	Art. No.	Colour	Size
BD	JU5C7B2000	Beige	S
	JU5C7B4000	Beige	L
	JU5C7A2000	Black	S
	JU5C7A4000	Black	L
	JU5C700000		Made-to-measure
BG	JU5C0B2000	Beige	S
	JU5C0B4000	Beige	L
	JU5C0A2000	Black	S
	JU5C0A4000	Black	L
	JU5C000000		Made-to-measure

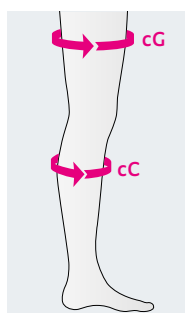

Circumferences in cm	Small	Large
cC	34 – 50	51 – 80
cG	50 – 71	72 – 108

Measuring point cC for BD garment.
Measuring point cC and cG for a BG garment.



circaid cover up whole leg black

circaid® juxtafit® premium shelf strap

Additional support and coverage.

- Offers additional support and coverage

Art. No.	Size	Size in cm
JU2Q001000	S	20.5 x 6.5 (without hook tabs)
JU2Q002000	L	25.5 x 9.0 (without hook tabs)
JU2Q000000	Made-to-measure	–

Note

It is recommended to always use a circaid supporting band in combination with a circaid garment. The indications of the circaid supporting band are identical to the indications of the corresponding circaid garment. Please order separately.



circaid juxtafit premium shelf strap

2
Phase

3
Phase



circaid® juxtafit® essentials arm

Adjustable compression device for optimising and maintaining decongestion results in lymphoedema treatment.

medi tip*:

Due to product features we recommend circaid juxtafit for:

- Men / women
- Optimising and maintaining decongestion results
- Patients who have challenges with medical compression armsleeves
- Up to 24 hour compression therapy

Indications

- Lymphoedema
- Other forms of oedema
- Lipoedema

Product features

- Easy handling – can be applied using one hand
- Easy handling – simple donning and doffing
- circaid Built-In-Pressure System (BPS): adjustable, controllable and re-adjustable compression
- Re-adjusting the individual bands avoids pressure loss and thus sliding down of the garment
- Inelastic material with high wall-stability for high working pressure
- Latex-free, odour-inhibiting material with anti-bacterial effect
- Available in standard sizes and as made-to-measure

Benefits

- Offering an alternative therapy solution for patients who are not able to apply or tolerate compression armsleeves
- Compression therapy – essential part of the complex lymphoedema therapy¹
- Easy handling allows for self-management of the patient
- Optimum addition to medical compression armsleeves – attractive armsleeves during the day and night compression with circaid garments
- Compression solution for optimising decongestion results and stabilising oedema fluctuations

Adjustable compression

10 – 20 mmHg
20 – 30 mmHg
30 – 40 mmHg

Product benefits



Built-In-Pressure



Variety



Juxtaped band



Easy handling



Inelastic



Breathe-O-Prene



Colours

Beige
S + M

S = Standard
M = Made-to-measure

Note

A video for application of the circaid juxtafit essentials arm can be found here: [medi.biz/jf](https://www.medi.biz/jf)

*Please consider, that this recommendation does not replace the diagnosis and consultation of a medical healthcare professional.

Studies

¹ Lymphoedema Framework. Best Practice for the Management of Lymphoedema. International consensus. London: MEP Ltd, 2006.

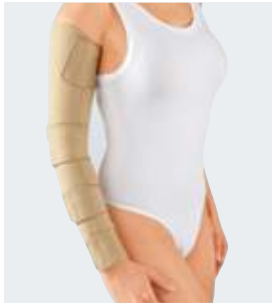

circaid juxtafit essentials arm

circaid® juxtafit® essentials arm standard styles

		CG	CG	CG			
Size / Art. No.		Extra short	Short	Long			
Left	1	JU2A781000	JU2A731000	JU2A031000			
	2	JU2A782000	JU2A732000	JU2A032000			
	3	JU2A783000	JU2A733000	JU2A033000			
	4	JU2A784000	JU2A734000	JU2A034000			
	5	JU2A785000	JU2A735000	JU2A035000			
	6	JU2A786000	JU2A736000	JU2A036000			
Right	1	JU2A791000	JU2A741000	JU2A041000			
	2	JU2A792000	JU2A742000	JU2A042000			
	3	JU2A793000	JU2A743000	JU2A043000			
	4	JU2A794000	JU2A744000	JU2A044000			
	5	JU2A795000	JU2A745000	JU2A045000			
	6	JU2A796000	JU2A746000	JU2A046000			
Circumferences in cm		1	2	3	4	5	6
cG		28–32	30–34	32–37	35–40	38–44	42–48
cF		26–30	28–32	30–35	33–38	36–41	39–45
cE		25–28	27–30	29–32	31–34	33–36	36–40
cD		23–26	25–28	27–30	29–32	31–34	33–37
cC		15–17	17–19	19–21	21–23	23–25	25–28
Length measurement in cm		Extra short	Short	Long			
∠C–G		< 38	38–48	> 48			

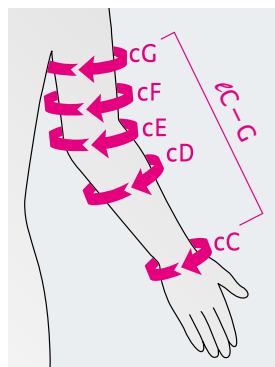



Your order for circaid juxtafit essentials arm includes:

- 1 adjustable compression garment
- 1 circaid Built-In-Pressure System (BPS) guide card
- 1 elbow band
- 1 circaid cover up arm

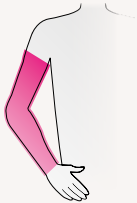

circaid juxtafit essentials arm with circaid juxtafit essentials hand wrap

circaid® juxtafit® essentials arm made-to-measure styles

	CG	AG
		
	Armsleeve without hand	Armsleeve with hand wrap
	made-to-measure	made-to-measure
Art. No.	JU2A000000	JU2H000000



circaid juxtafit essentials arm



circaid juxtafit essentials hand wrap

circaid® hand options

The following hand options are recommended to wear in combination with circaid juxtafit.

Note

It is recommended to always wear a circaid hand option in combination with a circaid arm garment. The indications of the circaid hand options are identical to the indications of the corresponding circaid arm garment.

circaid® juxtafit® essentials hand wrap

Adjustable compression device for the hand.

Product details

- Compresses the hand from the wrist to the base of the fingers
- Adjustable for additional pressure on the dorsum of the hand
- Simple handling – ideal for self-care
- Available in standard sizes only – for the left or right hand

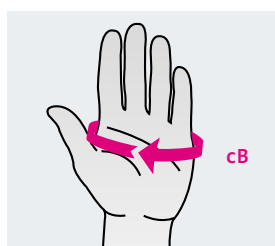

Size	Circumferences in cm / cB Palm	Art. No. / Left	Art. No. / Right
XS	14 – 17	JU2B031000	JU2B041000
S	17 – 20	JU2B032000	JU2B042000
M	20 – 23	JU2B033000	JU2B043000
L	23 – 26	JU2B034000	JU2B044000
XL	26 – 29	JU2B035000	JU2B045000

circaid® glove

Additional compression for the fingers.

Product details

- Provides light to moderate compression
- Individually adjustable length of the fingers
- Intuitive and simple donning
- Designed for left or right hand use
- It is recommended to always wear the circaid glove with a circaid arm garment

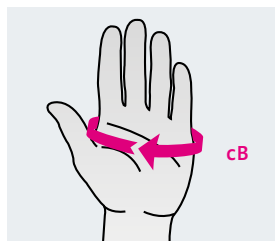

Circumference in cm	2	3	4	5	6
cB	18 – 21	20 – 23	22 – 25	24 – 27	26 – 29
Art. No.	JU5G002000	JU5G003000	JU5G004000	JU5G005000	JU5G006000



circaid juxtafit essentials glove

circaid® juxtafit® essentials glove

Adjustable compression device for the hand including fingers.

Product details

- Compresses the hand, including fingers
- Easy handling
- Includes a removal band to make removal easier
- Only available as made-to-measure

Styles	AC
	 <p>glove</p>
Size / Art. No.	made-to-measure JU2B000000





circaid juxtafit essentials glove with dorsum strap

circaid® juxtafit® essentials glove with dorsum strap

Adjustable compression glove for additional compression for the dorsum of the hand.

- circaid juxtafit essentials glove also available with additional or separate dorsum strap

Styles	AC	AC
	 <p>glove with dorsum strap</p>	 <p>separate dorsum strap</p>
Size / Art. No.	made-to-measure JU2L000000	made-to-measure JU2C000000





circaid juxtafit essentials open palm glove

circaid® juxtafit® essentials open palm glove

Adjustable compression device for the hand including fingers with open palm for easier donning.

- circaid juxtafit essentials glove also available with open palm and open palm with dorsum strap

Styles	AC	AC
	 <p>open palm glove</p>	 <p>open palm glove with dorsum strap</p>
Size / Art. No.	made-to-measure JU2F000000	made-to-measure JU2L100000

Note

A video for application of the circaid hand options can be found here: [medi.biz/jf](https://www.medi.biz/jf)

circaid® juxtafit® accessories

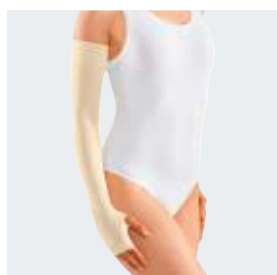

circaid undersleeve arm with thumb opening

circaid® undersleeves

Additional wearing comfort.

- Can be worn directly against the skin underneath circaid products to provide added comfort
- Note: does not provide therapeutic compression

Arm versions

- circaid undersleeve arm Standard with thumb opening
- circaid undersleeve arm silver with thumb opening

Standard size	Art. No.	Type	Style
Undersleeve arm	JULV009000		AG
	JUSV009000	Silver	AG



circaid cover up arm beige

circaid® cover up

Silky oversleeve for circaid garments.

- Can be worn over circaid arm garments.
- Prevents the garments from snagging on clothing or bedding
- Gives adjustable compression garments a refined look
- Available in black, beige and pink
- Note: does not provide therapeutic compression

Arm versions

Standard size	Art. No.	Colour	Size
CG	JU5U0B2000	Beige	S
	JU5U0B4000	Beige	L
	JU5U0P2000	Pink	S
	JU5U0P4000	Pink	L
	JU5U0A2000	Black	S
	JU5U0A4000	Black	L
	JU5U000000		Made-to-measure

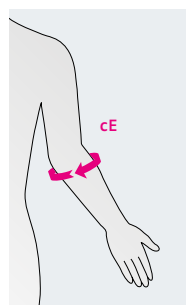

Circumferences in cm	Small	Large
cE	26 – 39	40 – 60



circaid juxtafit premium shelf strap

circaid® juxtafit® premium shelf strap

Additional support and coverage.

- Offers additional support and coverage

Art. No.	Size	Size in cm
JU2Q001000	S	20.5 x 6.5 (without hook tabs)
JU2Q002000	L	25.5 x 9.0 (without hook tabs)
JU2Q000000	Made-to-measure	–

Note

It is recommended to always use a circaid supporting band in combination with a circaid garment. The indications of the circaid supporting band are identical to the indications of the corresponding circaid garment. Please order separately.



A photograph of a person's leg and foot standing on a pink mat in a bathroom. The leg is positioned vertically, and the foot is resting on the mat. The background shows a white bathtub and a showerhead.

medi skin care

Compression garments are the central component of treating venous and lymphatic disorders. Skin care is an important complement to compression garments.

medi note:

medi care products are cosmetic products and may only be used on intact skin.

Your benefits

- Increase add-on sales / present as a full-line provider
- Confidence that the ingredients are perfectly matched to the compression garments
- Increase customer satisfaction by supplying ideal care for stressed skin
- Decreases wear and tear on the compression garments by encouraging smooth soft skin

An important tip for patients with allergies

All products meet the highest demands and are produced free of parabens (preservatives) and wool fat alcohols, and are latex-free.

The medi care products do not have a use-by or expiry date. They are marked with an “opened tub” and a month. This means that as soon as the tube has been opened and the contents are being used, the product should be used within 6, 9, or 12 months, as with shower gels, shampoos, etc.

medi skin care

The development of a venous and lymphatic disease increases the burden on the skin. The stretched wall of the vein leaks fluids into the surrounding tissue. The increased loss of water from the surface of the skin makes it more prone to injury. In order to enhance the success of compression therapy, products have been developed to meet the specific requirements of an affected leg.



medi day



You can find more information about the test carried out at www.dermatest-guarantee.de

medi day

Cooling gel with horse chestnut.

- Refreshing and cooling effect
- Well-nourished, smooth skin
- Reduces the feeling of tightness
- Supports user comfort of medical compression stockings

Use medi day directly before putting on the compression stockings and let the day begin.

Art. No.	Description
P400025000	medi day with 50 ml (unit with 6 pieces)
P400026000	medi day with 150 ml (unit with 6 pieces)
P400027000	medi day with 500 ml (1 piece)
P931009000	medi day Sachet 8 ml (unit with 20 pieces)



medi night



You can find more information about the test carried out at www.dermatest-guarantee.de

medi night

Skin care cream with regenerative hamamelis.

- To soothe and rejuvenate during the night
- Soothes the skin and also supports regeneration

Apply medi night after taking off the compression stockings.

Art. No.	Description
P500025000	medi night with 50 ml (unit with 6 pieces)
P500026000	medi night with 150 ml (unit with 6 pieces)
P941009000	medi day Sachet 8 ml (unit with 20 pieces)



medi fresh



You can find more information about the test carried out at www.dermatest-guarantee.de

medi fresh

Refreshing spray with menthol.

- For a hint of freshness throughout the day
- Feel refreshed straight away
- Can be used several times a day
- Gentle to the stocking fabric
- Easy to use everyday

Spray medi fresh any time on the stockings and enjoy its soothing effect.

Art. No.	Description
P900026000	medi fresh with 100 ml (unit with 6 pieces)





Service

On the following pages we have compiled all the relevant information you will need for ordering our products.

Order form for circaid® standard garments
 Telefax: +49 921 912-781, Email: orders@medi.de



Customer name _____ Customer no. _____
 Delivery address _____ Patient name _____
 Delivery date (client) _____ Order date _____ Measured by _____
 Tel no. _____ Email address _____

Stamp / Signature _____

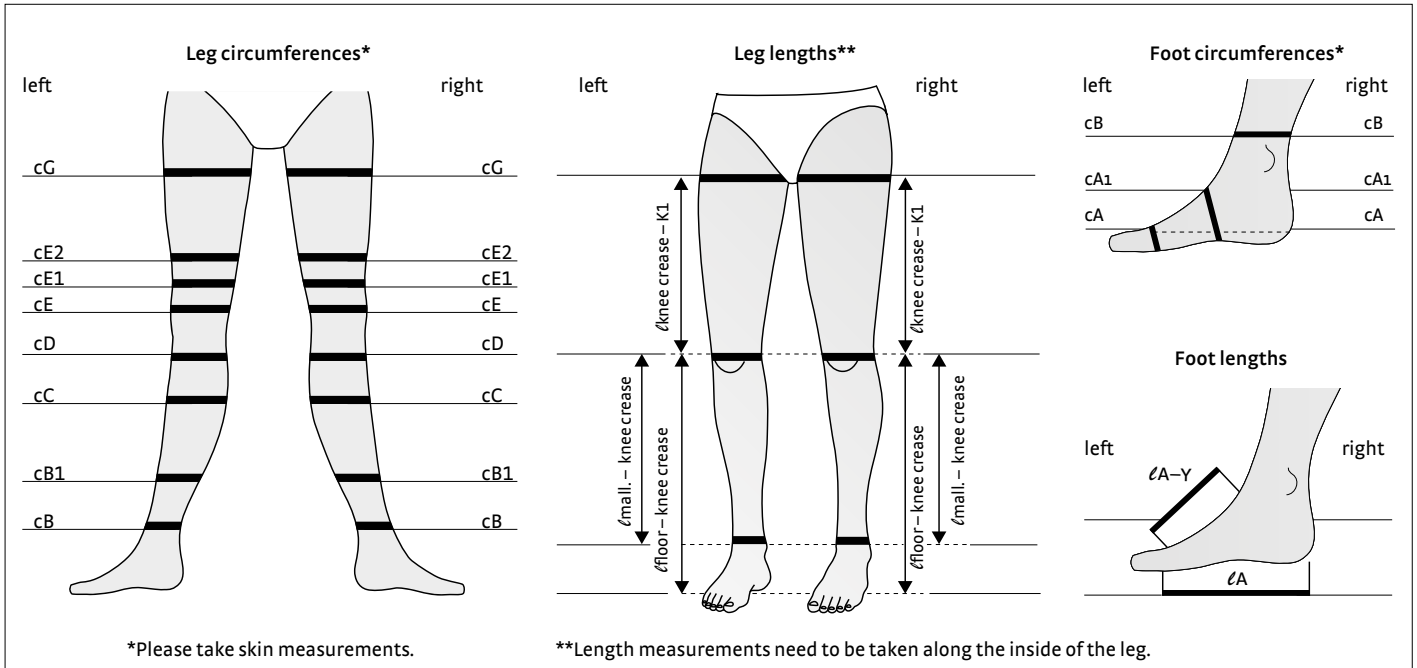

Garments	Quantity	Sizes								Length			Variant***	
		S	M	M-X	L	L-X	XL	XL-X	XXL	short	standard	long	anklet	undersock
circaid juxtacures***										short	standard	long	anklet	undersock
circaid juxtalite***		S	M	M-X	L	L-X	XL	XL-X	XXL	short		long	anklet	undersock
circaid juxtalite hd		S	M	M-X	L	L-X	XL	XL-X	XXL	short		long		
circaid reduction kit lower leg		standard		wide						short	standard	long		
circaid reduction kit knee														
circaid reduction kit upper leg		standard		wide						short	standard	long		
circaid juxtafit premium lower leg***		S	M	M-X	L	L-X	XL	XL-X	XXL	short		long	anklet	undersock
circaid juxtafit essentials lower leg***		S	M	M-X	L	L-X	XL	XL-X	XXL	short		long	anklet	undersock
circaid juxtafit essentials upper leg with knee	left	XXS	XS	S	M	L	XL			x-short	short	long		
	right	XXS	XS	S	M	L	XL			x-short	short	long		
circaid compression anklet		S	L											
circaid compressive undersock		standard		medium									moderate	firm
circaid power added compression band (pac band)		S	L	XL										
circaid juxtalite ankle foot wrap		S	M											
circaid customizable interlocking ankle foot wrap														
circaid juxtafit premium interlocking afw		S	M	L										
circaid juxtafit premium afw		S	M	L										
circaid single band afw														
circaid toe cap		2	3	4	5	6								

*** These products are available with circaid compression anklet or circaid compressive undersock moderate. Please choose accordingly.

For arm garments and accessories please see next page.

Order form for circaid® standard garments
 Telefax: +49 921 912-781, Email: orders@medi.de



Customer name _____ Customer no. _____

Delivery address _____ Patient name _____

Delivery date (client) _____ Order date _____ Measured by _____

Tel no. _____ Email address _____

Stamp / Signature _____

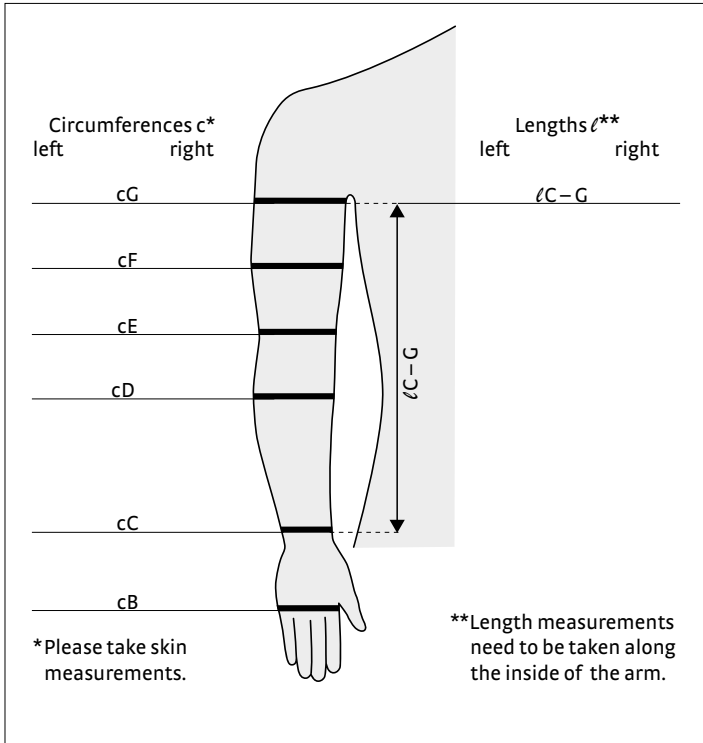

Notes

Garments	Quantity	Sizes						Length			Side		
		standard	wide	extra wide	standard	long				left	right		
circaid reduction kit arm													
circaid customizable hand wrap													
circaid juxtafit essentials arm		1	2	3	4	5	6	x-short	short	long	left	right	
circaid juxtafit essentials hand wrap			XS	S	M	L	XL				left	right	
circaid glove			2	3	4	5	6						

Accessories	Quantity	Sizes				Style		Colour		
		S	L			lower leg	whole leg	beige	black	pink
circaid reduction kit undersleeve						whole leg	arm			
circaid undersleeve leg						lower leg	whole leg			
circaid undersleeve leg silver						lower leg	whole leg			
circaid undersock						lower leg	whole leg			
circaid undersock silver						lower leg	whole leg			
circaid undersock cotton						lower leg	whole leg			
circaid undersleeve arm										
circaid undersleeve arm silver										
circaid cover up leg		S	L			lower leg	whole leg	beige	black	
circaid cover up arm		S	L					beige	black	pink
circaid reduction kit shelf strap										
circaid reduction kit lobe lifter										
circaid juxtafit premium shelf strap		S	L							

Correct fitting of circaid[®] adjustable compression devices leg

- Patient should be measured when limb is at its smallest
- Patient should be measured in standing position, if possible
- Patient limb should be maintained at time of measuring to ensure a proper fit

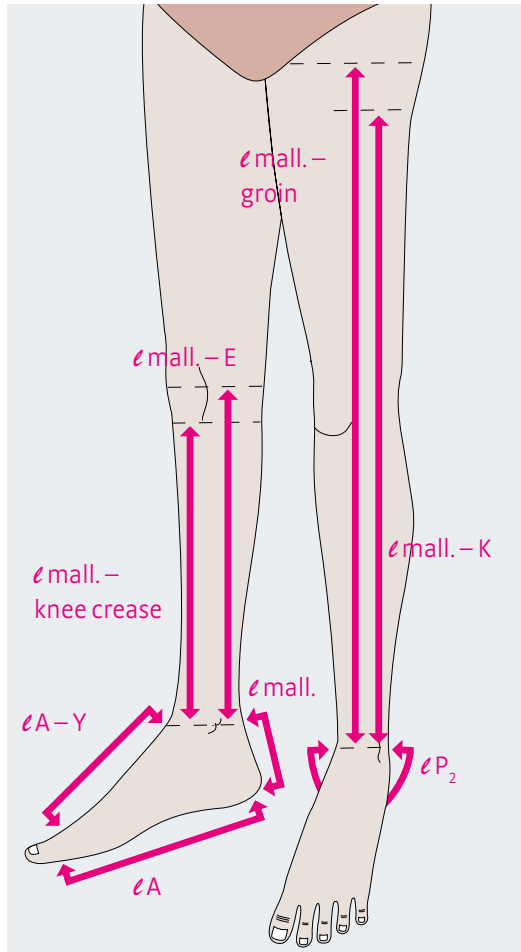

Length Measurements

Measurements start from malleolus

- **Measurement ℓ mall. – knee crease**
Medial length from the center of the malleolus to the knee crease (measurement ℓ mall. – knee crease is where garment will typically begin and end)
- **Measurement ℓ mall. – E**
Lateral length from the center of the malleolus to center of patella
- **Measurement ℓ mall. – groin**
Medial length from the center of the malleolus to groin, far enough below pubic area so that garment will not cause discomfort (measurement ℓ mall. – groin is where garment will typically begin and end)
- **Measurement ℓ mall. – K**
Lateral length from the center of the malleolus to the gluteal fold
- **Measurement ℓ mall.**
Length from floor to the center of the malleolus
- **Measurement ℓ A – Y**
Length from base of great toe to where foot meets ankle
- **Measurement ℓ A**
Length from base of toes to back of heel
- **Measurement ℓ P₂**
Length from malleolus to malleolus, pass under heel

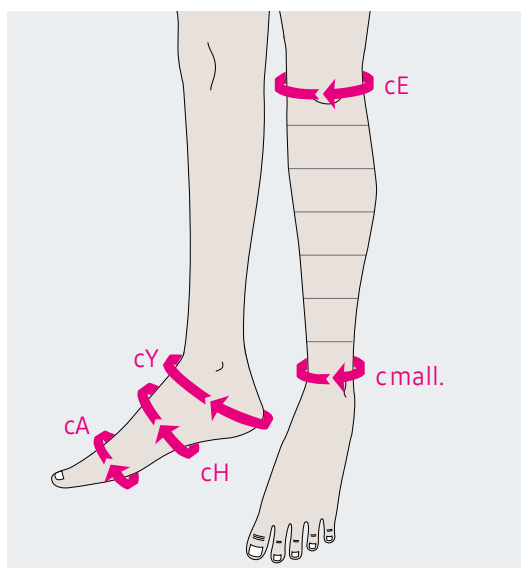

Circumference Measurements

- Take measurements without tension
- Measurements must be taken every 5 cm from the starting point center of malleolus

- **Measurement point c mall.**
Center of the malleolus
- **Measurement point cE**
Circumference at patella
- **Measurement point cY**
Circumference around heel to where foot meets ankle
- **Measurement point cH**
Arch circumference
- **Measurement point cA**
Circumference at base of toes

- Estimate
- 1st order
- Re-order

Order form for circaid juxtafit premium leg – made-to-measure
 Telefax: +49 921 912-781, e-mail: orders@medi.de



Customer name _____ Customer no. _____
 Delivery address _____ Patient name _____
 Delivery date (client) _____ Order date _____ Measured by _____
 Tel no. _____ Email address _____

Stamp / Signature _____

Leg measurement			Leg measurement		
Circumferences			Lengths		
Left in cm	Right in cm		Left in cm	Right in cm	
85					
80					
75					
70					
65					
60					
55					
50					
45					
40					
35					
30					
25					
20					
15					
10					
05					
c mall.					

Measurements must be every 5 cm from the starting point center of malleolus.

Foot measurement			Foot measurement		
Circumferences			Lengths		
Left in cm	Right in cm		Left in cm	Right in cm	
c mall.			ℓP ₂		
cY			ℓmall.		
cA1			ℓA-Y		
cA			ℓA		

Made-to-measure leg options					Standard foot options (separate only)		circaid cover up
circaid juxtafit premium <input type="checkbox"/> lower leg, add. lateral rise: <input type="checkbox"/> 5 cm <input type="checkbox"/> 10 cm <input type="checkbox"/> lower leg with knee <input type="checkbox"/> knee piece <input type="checkbox"/> upper leg <input type="checkbox"/> no lateral rise <input type="checkbox"/> upper leg with knee <input type="checkbox"/> no lateral rise <input type="checkbox"/> whole leg <input type="checkbox"/> no lateral rise	Left	Quantity	Right	Quantity	<input type="checkbox"/> circaid single band afw <input type="checkbox"/> circaid pac band <input type="checkbox"/> circaid juxtafit premium interlocking afw <input type="checkbox"/> circaid juxtafit premium afw Made-to-measure foot option <input type="checkbox"/> circaid juxtafit premium afw <input type="checkbox"/> attached <input type="checkbox"/> separate	Colour options <input type="checkbox"/> beige <input type="checkbox"/> black	

circaid juxtafit premium shelf strap <input type="checkbox"/> S <input type="checkbox"/> L <input type="checkbox"/> Made-to-measure	Notes _____ _____ _____
--	---

Correct fitting of circaid[®] adjustable compression devices arm

- Measure patient's arm length with the arm straight and circumferences when the limb is at its smallest
- Maintain arm size from the time of measuring to ensure a proper fit of the garment

The circaid juxtafit essentials arm length (measured medially) is determined from wrist-to-axilla length provided. A lateral rise is incorporated at the top of the garment in addition to a 10° bend at the elbow. circaid juxtafit essentials arm comes with one circaid cover up (a black cover up will be sent if a color is not selected).

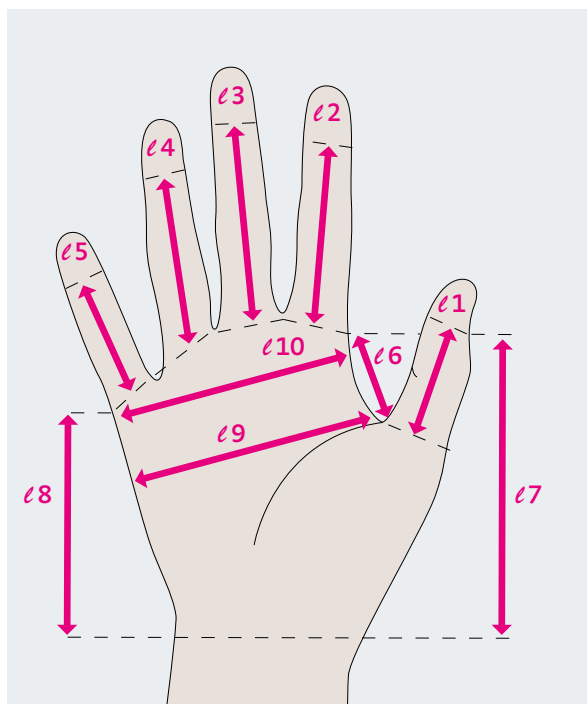

Length Measurements

- **Measurements l1–l5**
Length of finger from the center of the crease at base to where the glove should end
- **Measurement l6**
Length from base of index finger to the base of thumb webbing
- **Measurement l7**
Length from base of index finger (same as l6) to base of palm
- **Measurement l8**
Length from the crease between the ring finger and pinky finger to the base of the palm
- **Measurement l9**
Width of palm at base of thumb webbing
- **Measurement l10**
Width of palm at base of pinky finger

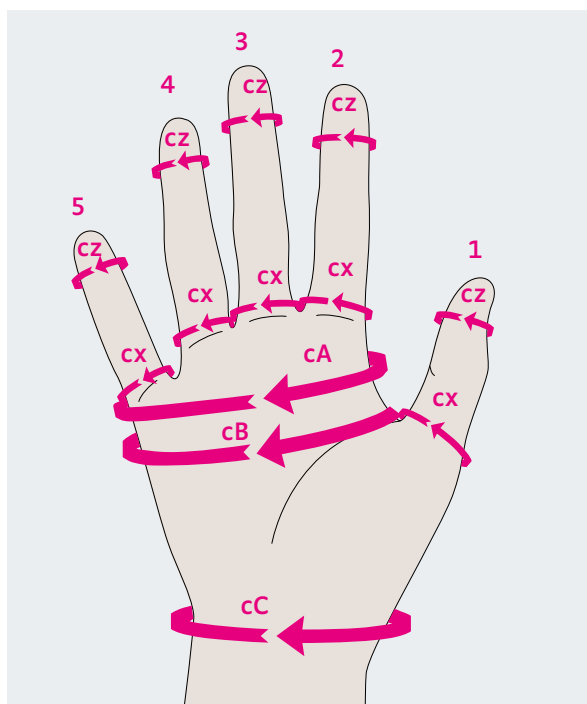

Circumference Measurements

Take measurements without tension

- **Measurements 1 cZ – 5 cZ**
The circumference where the glove should end; commonly, the Distal Interphalangeal joint (DIP)
- **Measurements 1 cX – 5 cX**
The circumference of each finger at the Proximal Interphalangeal joint (PIP) or if the base of the finger is larger than the PIP please use the larger measurements
- **Measurement cA**
Circumference of palm at base of pinky
- **Measurement cB**
Circumference of palm at base of thumb webbing
- **Measurement cC**
Circumference of the wrist

- Estimate
- 1st order
- Re-order

Order form for circaid juxtafit essentials arm – made-to-measure

Telefax: +49 921 912-781, e-mail: orders@medi.de



Customer name _____ Customer no. _____
 Delivery address _____ Patient name _____
 Delivery date (client) _____ Order date _____ Measured by _____
 Tel no. _____ Email address _____

Stamp / Signature _____

Please take measurements without tension!

Arm measurement

Circumferences

Left in cm	Right in cm
	55
	50
	45
	40
	35
	30
	25
	20
	15
	10
	05
	cC Wrist
	cB Palm

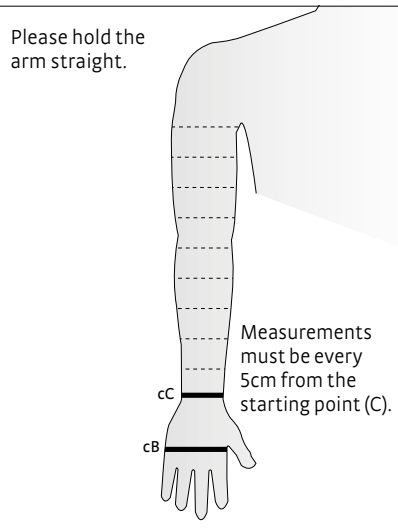

Please measure the length on the inside of the arm (from the wrist to elbow crease and from the wrist to axilla).

ℓC-G _____
ℓC-E _____

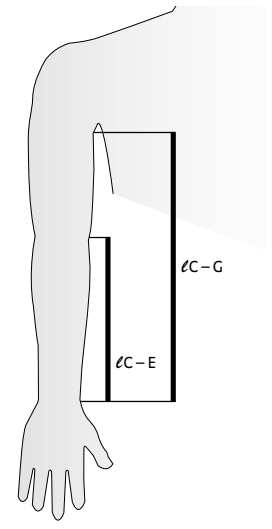

	1cZ
	2cZ
	3cZ
	4cZ
	5cZ
	1cX
	2cX
	3cX
	4cX
	5cX
	cA
	cB Palm
	cC Wrist

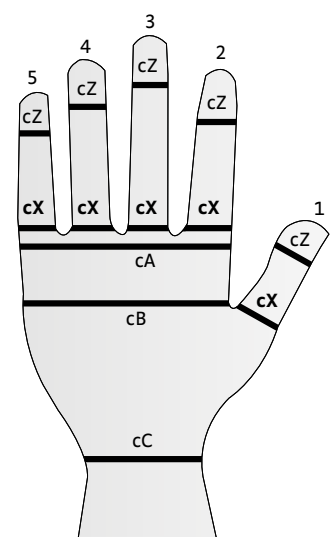

	ℓ1
	ℓ2
	ℓ3
	ℓ4
	ℓ5
	ℓ6
	ℓ7
	ℓ8
	ℓ9
	ℓ10

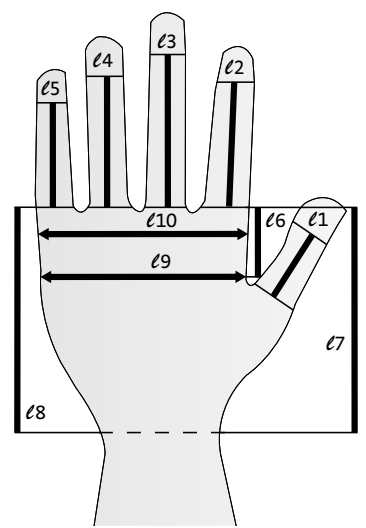

Made-to-measure options

circaid juxtafit essentials arm	Left	Quantity	Right	Quantity
<input type="checkbox"/> armsleeve	<input type="checkbox"/>	_____	<input type="checkbox"/>	_____
<input type="checkbox"/> glove	<input type="checkbox"/>	_____	<input type="checkbox"/>	_____
<input type="checkbox"/> glove with dorsum strap	<input type="checkbox"/>	_____	<input type="checkbox"/>	_____
<input type="checkbox"/> glove with open palm	<input type="checkbox"/>	_____	<input type="checkbox"/>	_____
<input type="checkbox"/> glove with dorsum strap and open palm	<input type="checkbox"/>	_____	<input type="checkbox"/>	_____
<input type="checkbox"/> hand wrap (standard sizes only)	<input type="checkbox"/>	_____	<input type="checkbox"/>	_____

circaid cover up

- Colour options**
- pink
 - beige
 - black

Notes

circaid[®]

intended purposes

circaid leg garments

The compression system is designed to provide compression to the leg for patients with venous and lymphatic disorders.

circaid foot options

The compression system is designed to provide compression to the foot and ankle for patients with venous and lymphatic disorders.

circaid toe cap

The compression system is designed to provide compression to the toes for patients with venous and lymphatic disorders.

circaid arm garments

The compression system is designed to provide compression to the arm for patients with venous and lymphatic disorders.

circaid hand options

The compression system is designed to provide compression to the hand for patients with venous and lymphatic disorders.

circaid glove

The compression system is designed to provide compression to the fingers for patients with venous and lymphatic disorders.

circaid supporting bands

Supporting band for application in combination with another circaid compression garment.

medi GmbH & Co. KG
Medicusstraße 1
95448 Bayreuth
Germany
T +49 921 912-0
F +49 921 912-781
export@medi.de
www.medi.de/en

medi Australia Pty Ltd
83 Fennell Street
North Parramatta NSW 2151
Australia
T +61 2 9890 8696
F +61 2 9890 8439
sales@mediaustralia.com.au
www.mediaustralia.com.au

medi Austria GmbH
Adamgasse 16/7
6020 Innsbruck
Austria
T +43 512 57 95 15
F +43 512 57 95 15 45
vertrieb@medi-austria.at
www.medi-austria.at

medi Belgium bvba
Posthoornstraat 13 / 1
3582 Koersel
Belgium
T +32 11 24 25 60
F +32 11 24 25 64
info@medibelgium.be
www.medibelgium.be

medi Canada Inc / médi Canada Inc.
597, Rue Duvernay, Verchères
QC Canada J0L 2R0
T +1 450 583 3317 / +1 800 361 3153
F +1 888 583 6827
service@medicanada.ca
www.medicanada.ca

medi Danmark ApS
Vejlegardsvej 59
2665 Vallensbaek Strand
Denmark
T +45 70 25 56 10
F +45 70 25 56 20
kundeservice@sw.dk
www.medit danmark.dk

medi Bayreuth Espana SL
C / Canigo 2 – 6 bajos
Hospitalet de Llobregat
08901 Barcelona
Spain
T +34 932 60 04 00
F +34 932 60 23 14
medi@mediespana.com
www.mediespana.com

medi France
Z. I. Charles de Gaulle
25, rue Henri Farman
93297 Tremblay en France Cedex
France
T +33 1 48 61 76 10
F +33 1 49 63 33 05
infos@medi-france.com
www.medi-france.com

medi Hungary Kft.
Bokor u. 21.
1037 Budapest
Hungary
T +36 1 371-0090
F +36 1 371-0091
info@medi.hu
www.medi.hu

medi Italia s. r. l.
Via Giuseppe Ghedini, 2
40069 Zola Predosa (BO)
Italy
T +39 051 6 13 24 84
F +39 051 6 13 29 56
info@medi-italia.it
www.medi-italia.it

medi Nederland BV
Heusing 5
4817 ZB Breda
The Netherlands
T +31 76 57 22 555
F +31 76 57 22 565
info@medi.nl
www.medi.nl

medi Norway AS
Vestheimvegen 35
4250 Kopervik
Norway
T +47 52 84 45 00
F +47 52 84 45 09
post@medinorway.no
www.medinorway.no

medi Polska Sp. z. o. o.
ul. Łabędzka 22
44-121 Gliwice
Poland
T +48 32 230 60 21
F +48 32 202 87 56
info@medi-polska.pl
www.medi-polska.pl

medi Bayreuth Unipessoal, Lda
Rua do Centro Cultural, no. 43
1700-106 Lisbon
Portugal
T +351 21 843 71 60
F +351 21 847 08 33
medi.portugal@medibayreuth.pt
www.medi.pt

medi RUS LLC
Business Center NEO GEO
Butlerova Street 17
117342 Moscow
Russia
T +7 495 374 04 56
F +7 495 374 04 56
info@medirus.ru
www.medirus.ru

medi Sweden AB
Box 6034
19206 Sollentuna
Sweden
T +46 8 969798
F +46 8 6266870
info@medi.se
www.medi.se

medi UK Ltd.
Plough Lane
Hereford HR4 OEL
Great Britain
T +44 1432 37 35 00
F +44 1432 37 35 10
enquiries@mediuk.co.uk
www.mediuk.co.uk

medi Ukraine LLC
Evhena Sverstiuka str, 11
Kiev 02002
Ukraine
T +380 44 591 11 63
F +380 44 392 73 73
info@medi.ua
http://medi.ua

medi USA L.P.
6481 Franz Warner Parkway
Whitsett, N. C. 27377-3000
USA
T +1 336 4 49 44 40
F +1 888 5 70 45 54
info@mediusa.com
www.mediusa.com

medi Trading (Shanghai) Co. Ltd.
Room 105, Building No. 4,
Lane 500 ShengXia Road
Pudong New District
201210 Shanghai
People's Republic of China
T +86 21 61761988
F +86 21 61769607
infocn@medi.cn

Medi Turk Ortopedi Medikal Ic ve Dis Tic. AS
Mustafa Kemal Mah. 2156 Sokak No: 16 / 4 – 5
06510 Çankaya Ankara
Turkey
T +90 312 435 20 26
F +90 312 434 17 67
info@medi-turk.com
www.medi-turk.com

MAXIS a. s.
medi group company
Slezská 2127 / 13
120 00 Prague 2
Czech Republic
T +420 571 633 510
F +420 571 616 271
info@maxis-medica.com
www.maxis-medica.com

Tachezy Sanit Srl.
Via Druso 48 / a
39100 Bolzano
Italy
T +39 0471 288 068
F +39 0471 282 773
info@tachezysanit.com
www.tachezysanit.com

